

Modeling Temporal Dynamics & Geographical Language Variations in Social Streams

Rutgers, The State University of New Jersey

Nov. 12, 2012

Liangjie Hong, Ph.D. Candidate
Dept. of Computer Science and Engineering
Lehigh University
Bethlehem, PA

Temporal Dynamics & Geographical Language Variations

- Motivation
- Modeling Social Streams
- Future work

Temporal Dynamics & Geographical Language Variations

- Motivation
- Modeling Social Streams
 - Modeling Popular Messages [WWW 2011]
 - Modeling Personal Decision & Content [WSDM 2013]
 - Empirical Topic Modeling Study [SOMA 2010]
 - Temporal Dynamics [KDD 2011]
 - Geographical Language Variations [WWW 2012]
- Future work

Temporal Dynamics & Geographical Language Variations

- Motivation
- Modeling Social Streams
 - Modeling Popular Messages [WWW 2011]
 - Modeling Personal Decision & Content [WSDM 2013]
 - Empirical Topic Modeling Study [SOMA 2010]
 - **Temporal Dynamics [KDD 2011]**
 - **Geographical Language Variations [WWW 2012]**
- Future work

Temporal Dynamics & Geographical Language Variations

Motivation

The Blossom of Social Media



Temporal Dynamics & Geographical Language Variations

Motivation

Social Streams

The image displays a collage of social media interfaces, primarily Facebook and LinkedIn, illustrating the concept of 'Social Streams'. On the left, a LinkedIn profile for Samuel W. Lessin is shown, featuring a navigation bar with 'Home', 'Profile', 'Contacts', and 'Groups'. Below this, a 'Social Planning Sessions' section is visible, along with a 'LinkedIn Today recommends' section featuring a frog meme and a news snippet about a former CEO. The main content area shows a 'News Feed' with updates from friends, including one from Rick Sangerman and another from Tonya Walker. A 'Friends Online' list is also present. On the right, a Facebook 'News Feed' is shown, featuring a search bar, a 'What's on your mind?' text box, and several news items, including one about a friend becoming a fan of Buddy Media. A 'Who Needs Friends' sponsored post is also visible. Below the news feed, a 'Thank you Samuel' sponsored post is shown, along with a 'Find Friends' button and an 'Events' section. On the far right, a vertical stream of tweets is displayed, including one from acitrano and another from TheLaughingImp.

Temporal Dynamics & Geographical Language Variations

Motivation

Social Streams



Temporal Dynamics & Geographical Language Variations

Motivation

Social Streams



Temporal Dynamics & Geographical Language Variations

Motivation

Social Streams



Temporal Dynamics & Geographical Language Variations

Motivation

Challenges

Temporal Dynamics & Geographical Language Variations

Motivation

Challenges: Temporal Dynamics

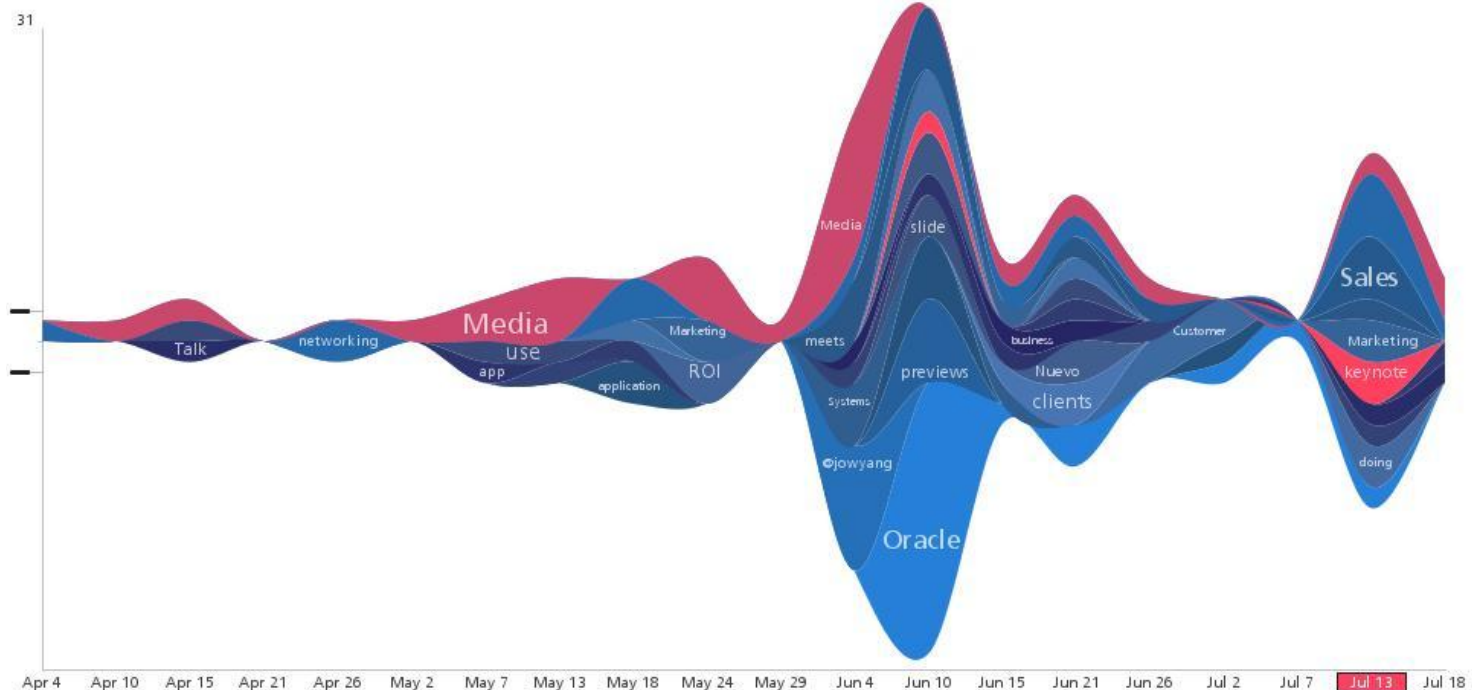

Temporal Dynamics & Geographical Language Variations

Motivation

Challenges: Multiple Sources



Temporal Dynamics & Geographical Language Variations

Motivation

Challenges: Meta-data



Temporal Dynamics & Geographical Language Variations

Motivation

Challenges: Meta-data



Temporal Dynamics & Geographical Language Variations

Motivation

Challenges

- Temporal dynamics
- Multiple sources
- Geographical locations

Temporal Dynamics & Geographical Language Variations

Motivation

***Technical* Challenges**

- **Multi-facet data**
- **Large scale**
- **Incorporate other research advances**

Temporal Dynamics & Geographical Language Variations

Temporal Dynamics + Multiple Sources
Geographical Language Variations

Modeling Temporal Dynamics

Motivation

Interesting Questions

- Are there any common topics among multiple media sources?



Modeling Temporal Dynamics

Motivation

Interesting Questions

- Are there any common topics among multiple media sources?
- How can we find them, automatically?



Modeling Temporal Dynamics

Motivation

Interesting Questions

- Are there any common topics among multiple media sources?
- How can we find them, automatically?
- Are they transferred from one source to another?



Modeling Temporal Dynamics

Motivation

Interesting Questions

- Are there any common topics among multiple media sources?
- How can we find them, automatically?
- Are there transferred from one source to another?
- [Zhao et al. ECIR 2011]



Modeling Temporal Dynamics

Motivation

Applications

Data Visualization

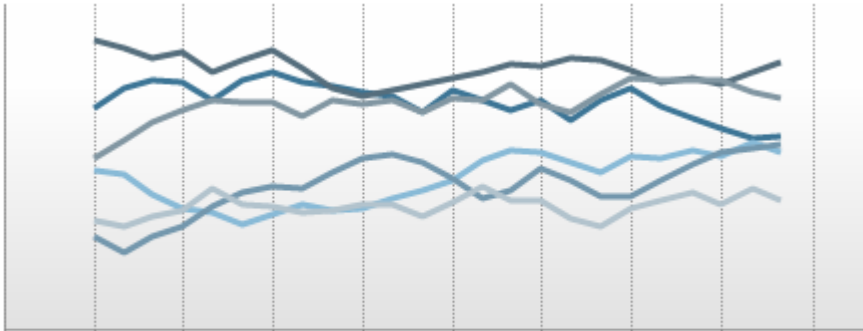

Trend Prediction



Modeling Temporal Dynamics

Motivation

Goal

- Identify common/local topics from multiple streams
- Characterize their temporal dynamics
- *Principled way*

Modeling Temporal Dynamics

Our Proposed Model

Our Approach

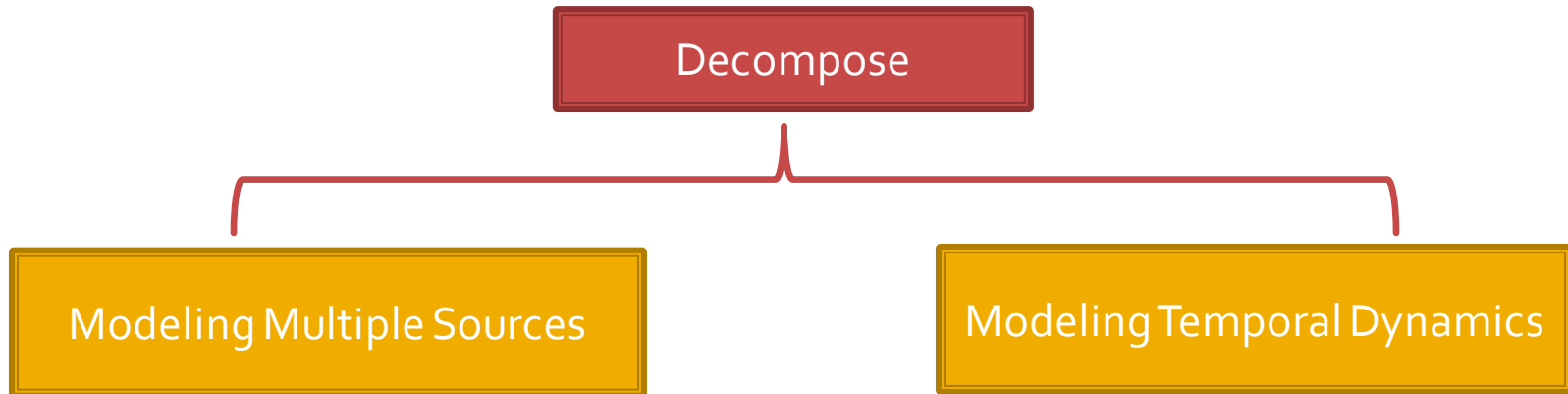

Modeling Temporal Dynamics

Our Proposed Model

Our Approach

Decompose

```
graph TD; A[Decompose] --> B[Modeling Multiple Sources]; A --> C[Modeling Temporal Dynamics];
```

Modeling Multiple Sources

Modeling Temporal Dynamics

Introduce common topics & local topics

Modeling Temporal Dynamics

Our Proposed Model

Our Approach

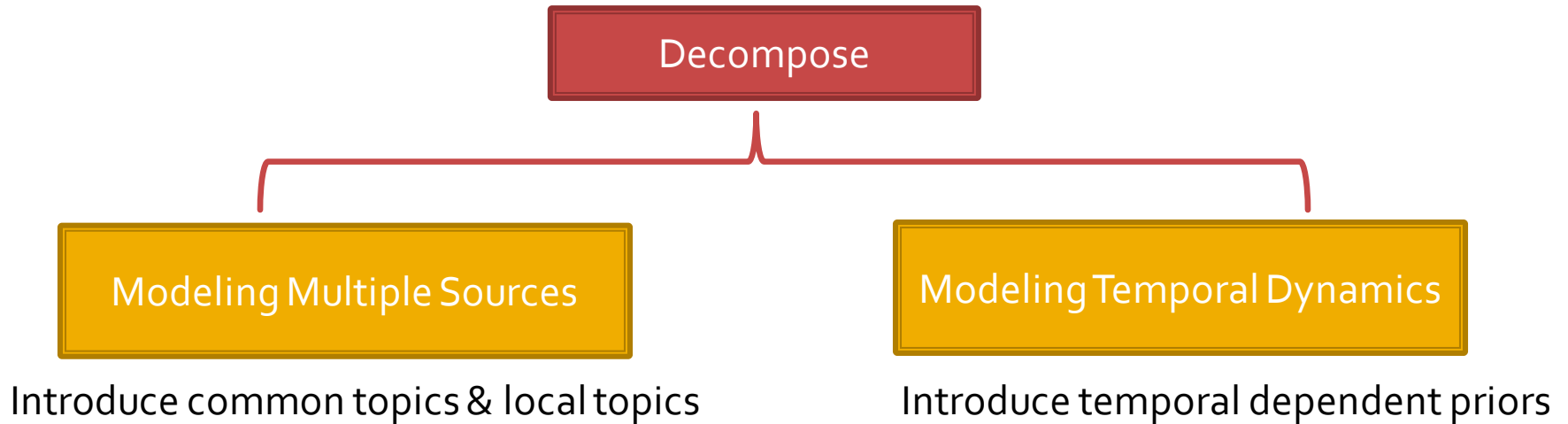

Modeling Temporal Dynamics

Basic Setting

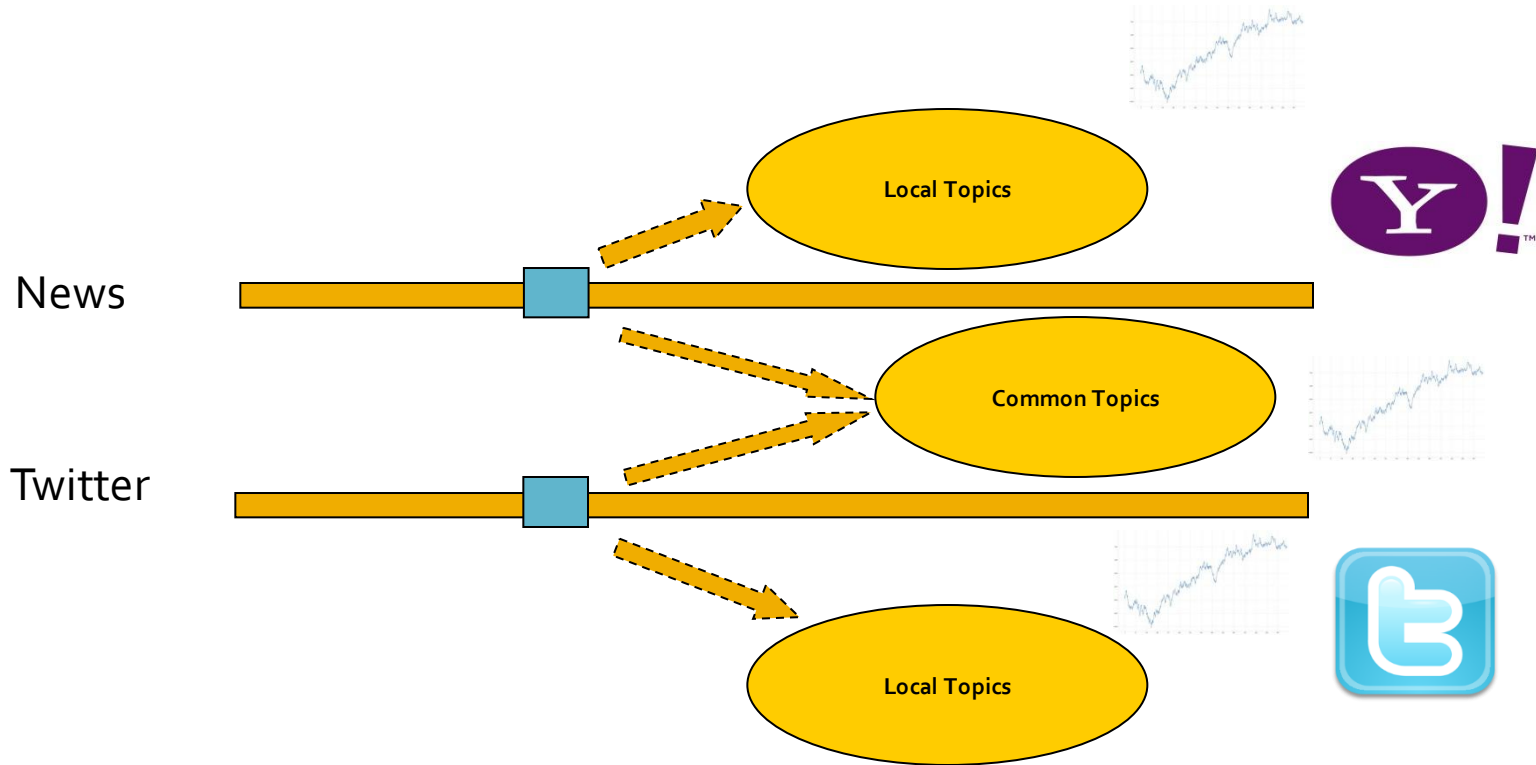

Modeling Temporal Dynamics

Handling Multiple Sources

- Basic Intuitions

- Some topics are shared.

Tsunami, Super bowl, NBA...

- Some topics are specific to a certain stream.

Local news, Personal opinions...

- Each stream is a mixture of them.

Modeling Temporal Dynamics

Handling Multiple Sources

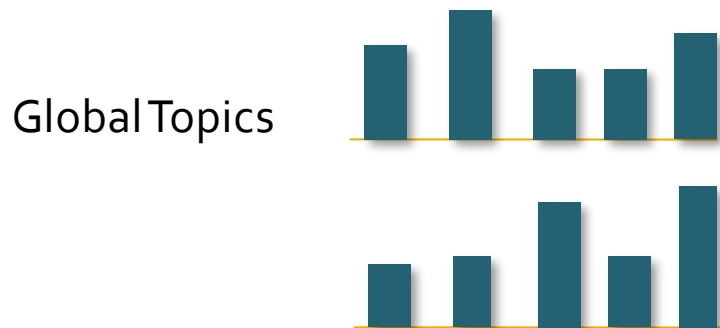

distribution over words

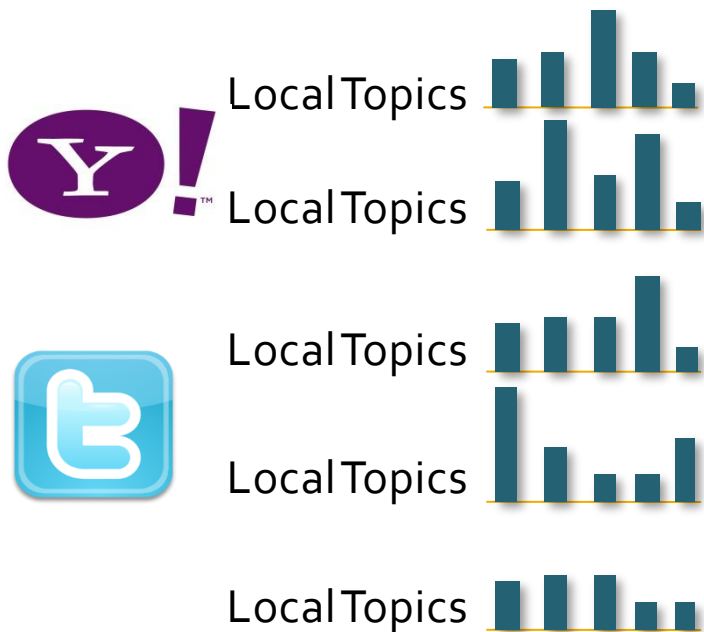

Modeling Temporal Dynamics

Handling Multiple Sources

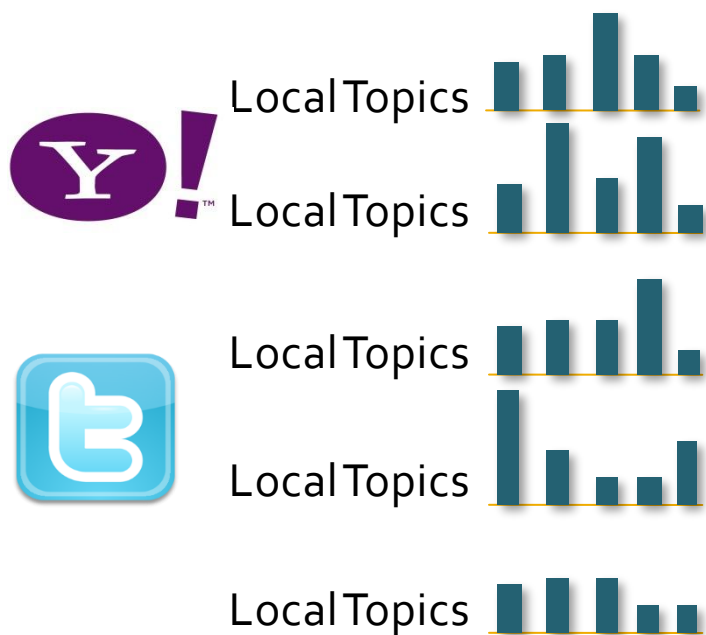
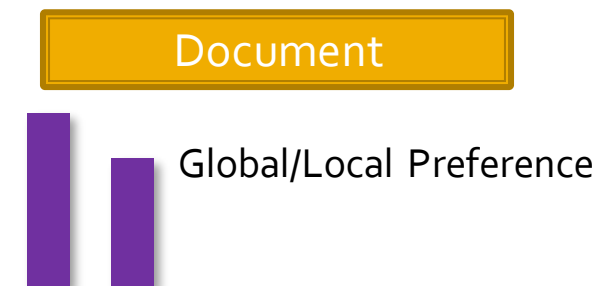
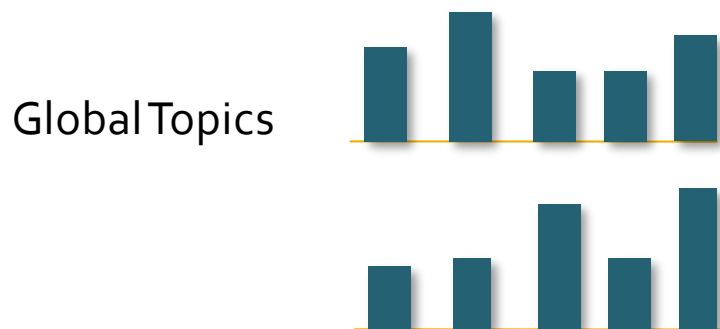

Modeling Temporal Dynamics

Handling Multiple Sources

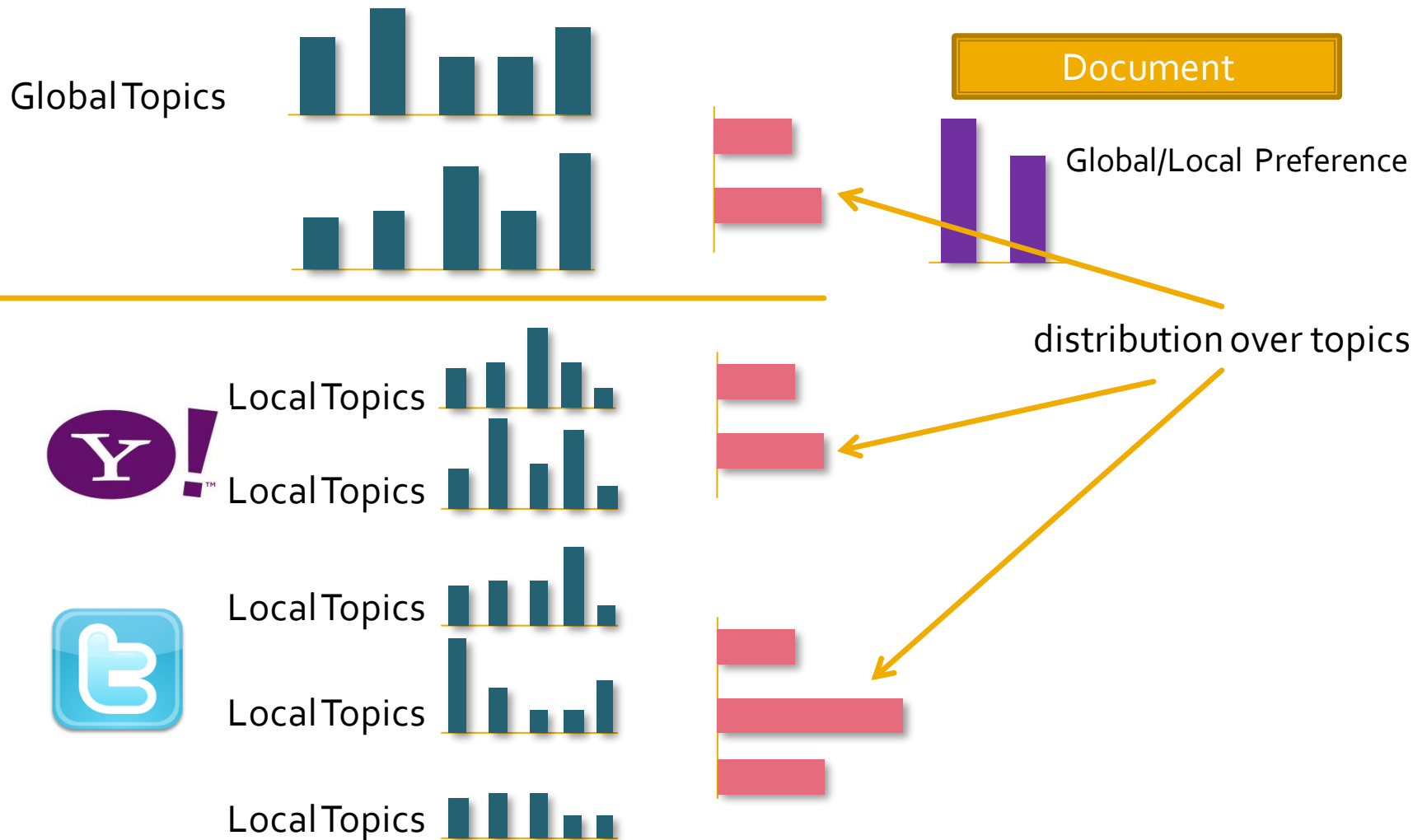

Modeling Temporal Dynamics

Handling Multiple Sources

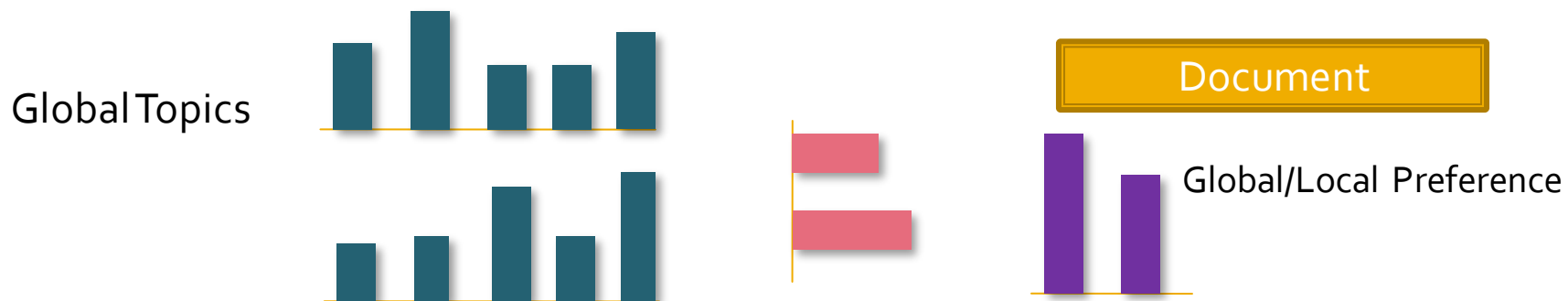

Modeling Temporal Dynamics

Handling Multiple Sources

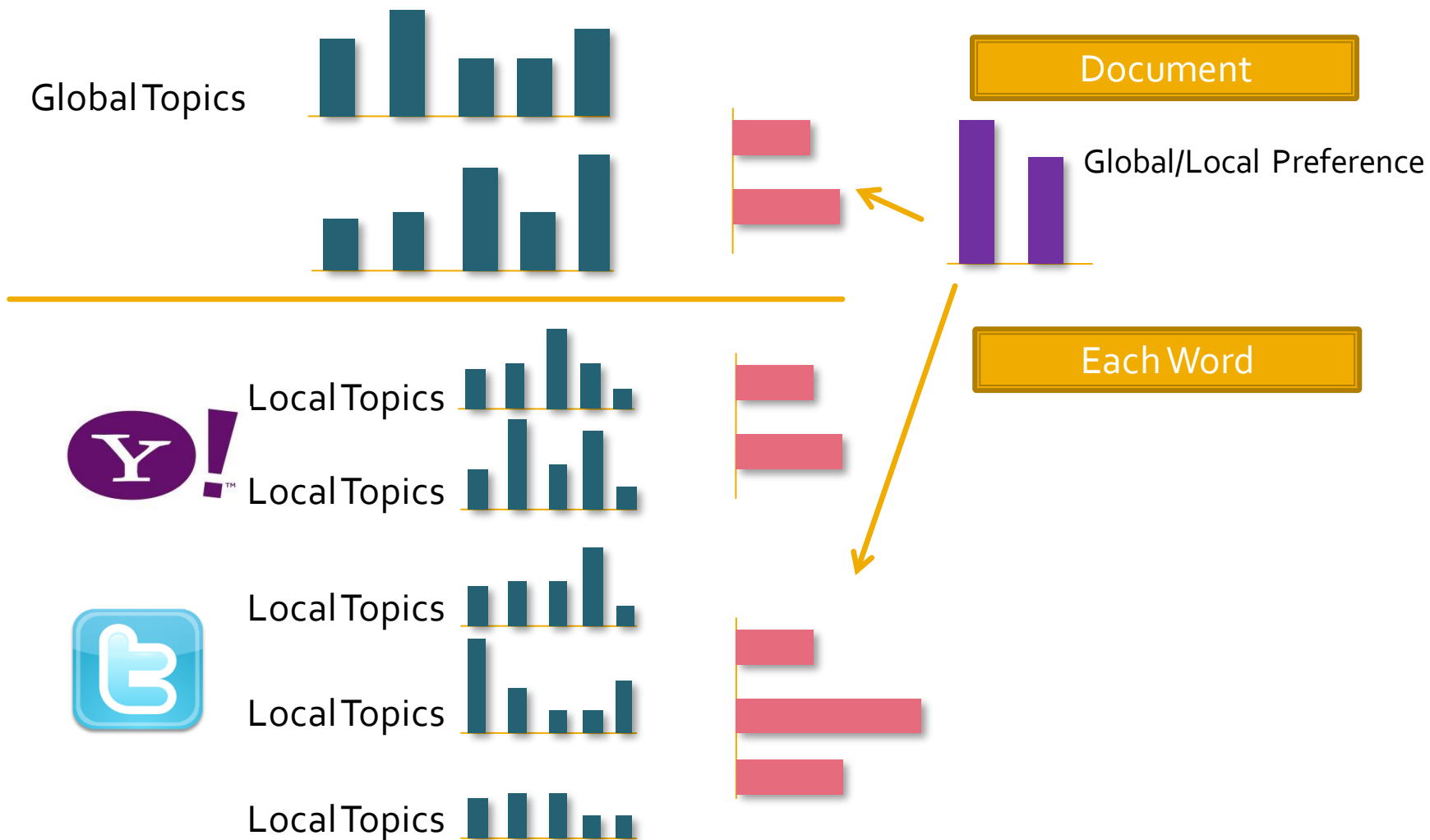

Modeling Temporal Dynamics

Handling Multiple Sources



Modeling Temporal Dynamics

Handling Multiple Sources



Modeling Temporal Dynamics

Temporal Modeling

Meme Tracking

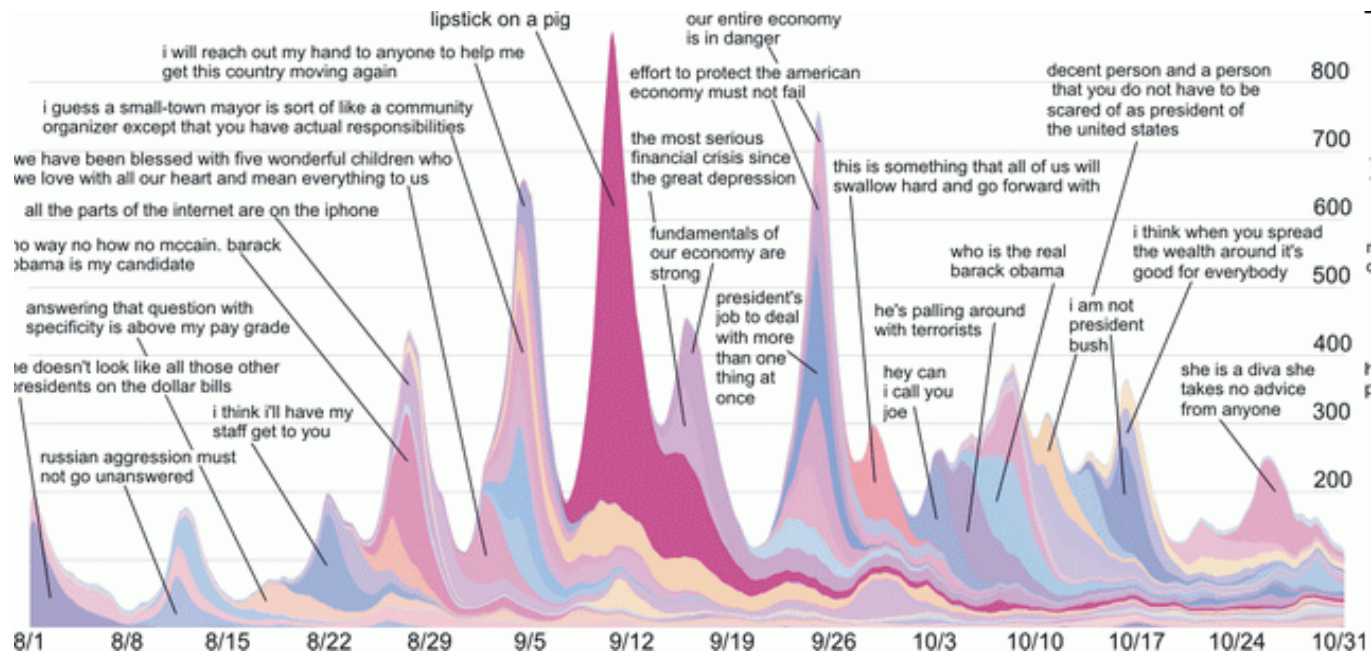

Modeling Temporal Dynamics

Temporal Modeling

Intuitions

Modeling Temporal Dynamics

Temporal Modeling

Intuitions

- Markovian Assumption

Modeling Temporal Dynamics

Temporal Modeling

Intuitions

- Markovian Assumption
 - [Blei and Lafferty, ICML 2007]
 - [Wang et al., UAI 2008]
 - [Wei et al., IJCAI 2007]

Modeling Temporal Dynamics

Temporal Modeling

Intuitions

- Markovian Assumption
- Use a function to characterize the changes of topic proportions over time

[Wang and McCallum, KDD 2006]

[Yin et al., ICDM 2011]

Modeling Temporal Dynamics

Temporal Modeling

Intuitions

- Markovian Assumption
- Use a function to characterize the changes of topic proportions over time
 - At certain time t , we will have higher prior probability to choose some

Assumptions

- Each topic only has one peak
- All topics are “trending”

Assumptions

- Each topic only has one peak
- All topics are “trending”

-
- Yes, it's naïve & simplified & unrealistic...

Modeling Temporal Dynamics

Temporal Modeling

Temporal Function

$$\alpha_{t,k} = A_k t^{M_k} \exp(-L_k t)$$

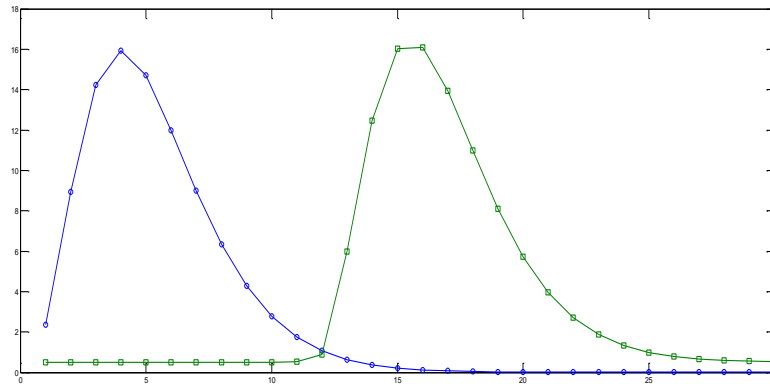

Modeling Temporal Dynamics

Temporal Modeling

Temporal Function

$$\alpha_{t,k} = A_k t^{M_k} \exp(-L_k t)$$

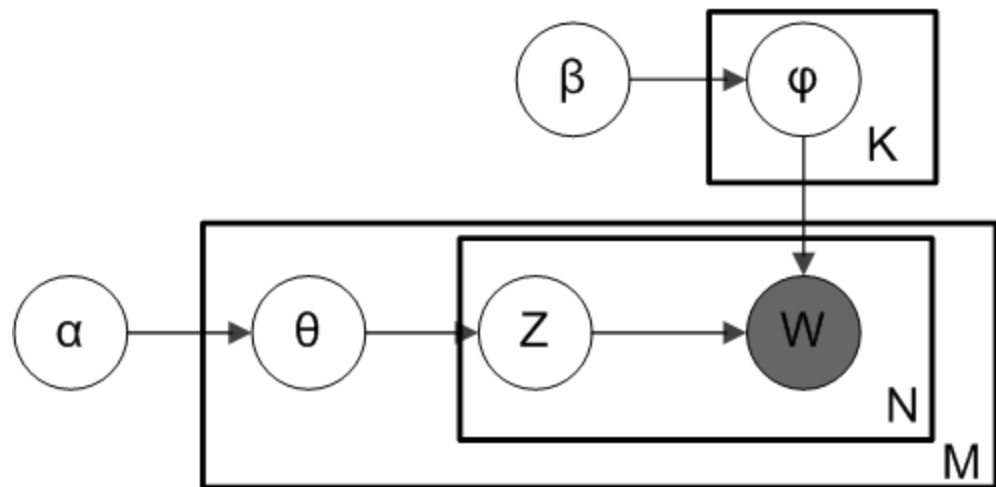
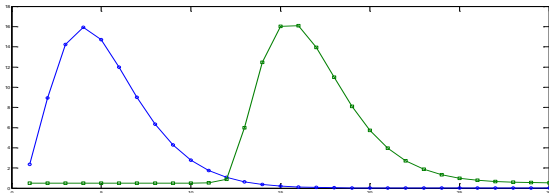

Temporal Modeling

- Overall Algorithm
 - EM-Style Algorithm
 - Gibbs Sampling in E-step
 - Functional Optimization in M-step
Non-linear Least Square fit

Temporal Modeling

- Experiments & Conclusions
 - News & Tweets
 - 233,488 News articles
 - 1,736,350 Tweets
 - 720 hours in May, 2010

Modeling Temporal Dynamics

Temporal Modeling

- Experiments & Conclusions

Comparison of Top Ranked Common Topics between LDA (Left) and Temporal Collection (Right)

Title	Top Terms	Title	Top Terms
"finance"	percent billion bank market greece financial banks debt	"finance"	percent billion bank greece financial debt banks euro crisis
"crime"	police car times vehicle found york square street bomb	"oil spill"	oil gulf spill coast drilling mexico water louisiana
"junk"	link cont via #jobs #fb album super live wii #tcot #news	"world cup"	world cup team league final players south season club
"oil spill"	oil gulf spill coast mexico gas drilling sea water	"health care"	health medical care cancer hospital patients study research
"junk"	dont people cant thats youre bad look tell talk	"UK election"	minister party prime cameron political leader president

Comparison of Local Topics between News (Left) and Twitter (Right)

News		Twitter	
Title	Top Terms	Title	Top Terms
"crime"	police car times vehicle found york square street	"social media"	blog video post check news via twitter online facebook
"US election"	election party law president vote political campaign	"hash tags"	#fb info #quote #fail #ge #lol #ff #twibbon cont
"China"	minister china south india north chinese korea indian	"non-English"	les pas pour sur une cest est qui avec bien suis tout faire
"jobs"	budget tax million money pay bill federal increase cuts	"junk"	cant this wait watch next believe gonna watching just
"education"	school students schools board education district college	"junk"	that would have could never were wish there

Modeling Temporal Dynamics

Temporal Modeling

- Experiments & Conclusions

Comparison of Top Ranked Common Topics between LDA (Left) and Temporal Collection (Right)

Title	Top Terms	Title	Top Terms
"finance"	percent billion bank market greece financial banks debt	"finance"	percent billion bank greece financial debt banks euro crisis
"crime"	police car times vehicle found york square street bomb	"oil spill"	oil gulf spill coast drilling mexico water louisiana
"junk"	link cont via #jobs #fb album super live wii #tcot #news	"world cup"	world cup team league final players south season club
"oil spill"	oil gulf spill coast mexico gas drilling sea water	"health care"	health medical care cancer hospital patients study research
"junk"	dont people cant thats youre bad look tell talk	"UK election"	minister party prime cameron political leader president

Comparison of Local Topics between News (Left) and Twitter (Right)

News		Twitter	
Title	Top Terms	Title	Top Terms
"crime"	police car times vehicle found york square street	"social media"	blog video post check news via twitter online facebook
"US election"	election party law president vote political campaign	"hash tags"	#fb info #quote #fail #ge #lol #ff #twibbon cont
"China"	minister china south india north chinese korea indian	"non-English"	les pas pour sur une cest est qui avec bien suis tout faire
"jobs"	budget tax million money pay bill federal increase cuts	"junk"	cant this wait watch next believe gonna watching just
"education"	school students schools board education district college	"junk"	that would have could never were wish there

Modeling Temporal Dynamics

Temporal Modeling

- Experiments & Conclusions

Comparison of Top Ranked Common Topics between LDA (Left) and Temporal Collection (Right)

Title	Top Terms	Title	Top Terms
"finance"	percent billion bank market greece financial banks debt	"finance"	percent billion bank greece financial debt banks euro crisis
"crime"	police car times vehicle found york square street bomb	"oil spill"	oil gulf spill coast drilling mexico water louisiana
"junk"	link cont via #jobs #fb album super live wii #tcot #news	"world cup"	world cup team league final players south season club
"oil spill"	oil gulf spill coast mexico gas drilling sea water	"health care"	health medical care cancer hospital patients study research
"junk"	dont people cant thats youre bad look tell talk	"UK election"	minister party prime cameron political leader president

Comparison of Local Topics between News (Left) and Twitter (Right)

News		Twitter	
Title	Top Terms	Title	Top Terms
"crime"	police car times vehicle found york square street	"social media"	blog video post check news via twitter online facebook
"US election"	election party law president vote political campaign	"hash tags"	#fb info #quote #fail #ge #lol #ff #twibbon cont
"China"	minister china south india north chinese korea indian	"non-English"	les pas pour sur une cest est qui avec bien suis tout faire
"jobs"	budget tax million money pay bill federal increase cuts	"junk"	cant this wait watch next believe gonna watching just
"education"	school students schools board education district college	"junk"	that would have could never were wish there

Modeling Temporal Dynamics

Temporal Modeling

- Experiments & Conclusions

Comparison of Top Ranked Common Topics between LDA (Left) and Temporal Collection (Right)

Title	Top Terms	Title	Top Terms
"finance"	percent billion bank market greece financial banks debt	"finance"	percent billion bank greece financial debt banks euro crisis
"crime"	police car times vehicle found york square street bomb	"oil spill"	oil gulf spill coast drilling mexico water louisiana
"junk"	link cont via #jobs #fb album super live wii #tcot #news	"world cup"	world cup team league final players south season club
"oil spill"	oil gulf spill coast mexico gas drilling sea water	"health care"	health medical care cancer hospital patients study research
"junk"	dont people cant thats youre bad look tell talk	"UK election"	minister party prime cameron political leader president

Comparison of Local Topics between News (Left) and Twitter (Right)

News		Twitter	
Title	Top Terms	Title	Top Terms
"crime"	police car times vehicle found york square street	"social media"	blog video post check news via twitter online facebook
"US election"	election party law president vote political campaign	"hash tags"	#fb info #quote #fail #ge #lol #ff #twibbon cont
"China"	minister china south india north chinese korea indian	"non-English"	les pas pour sur une cest est qui avec bien suis tout faire
"jobs"	budget tax million money pay bill federal increase cuts	"junk"	cant this wait watch next believe gonna watching just
"education"	school students schools board education district college	"junk"	that would have could never were wish there

Temporal Modeling

- Experiments & Conclusions
Case Study on A Common Topic “Kentucky Derby”
 - Select a common topic which ranks the following terms high:
“derby”, “race”, “borel”, “kentucky” and “horse” ...
 - Tracking temporal dynamics of a topic



Modeling Temporal Dynamics

Temporal Modeling

- Experiments & Conclusions

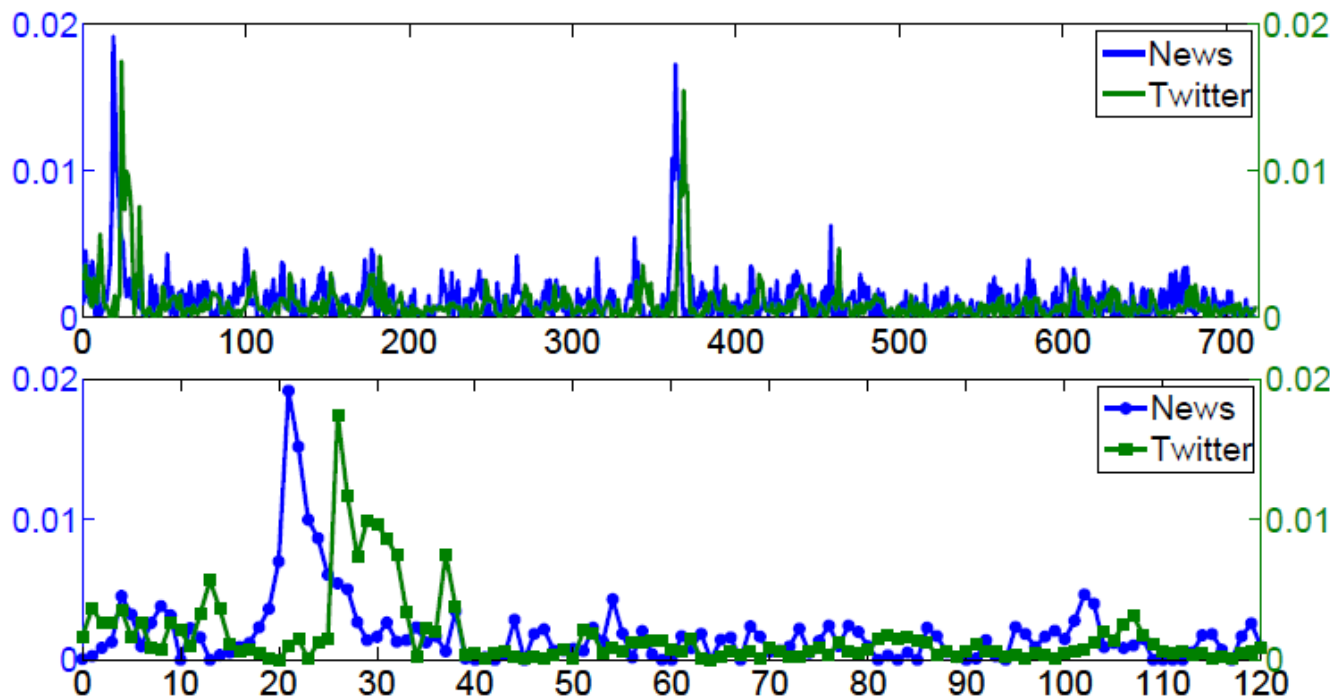

Modeling Temporal Dynamics

Temporal Modeling

- Experiments & Conclusions

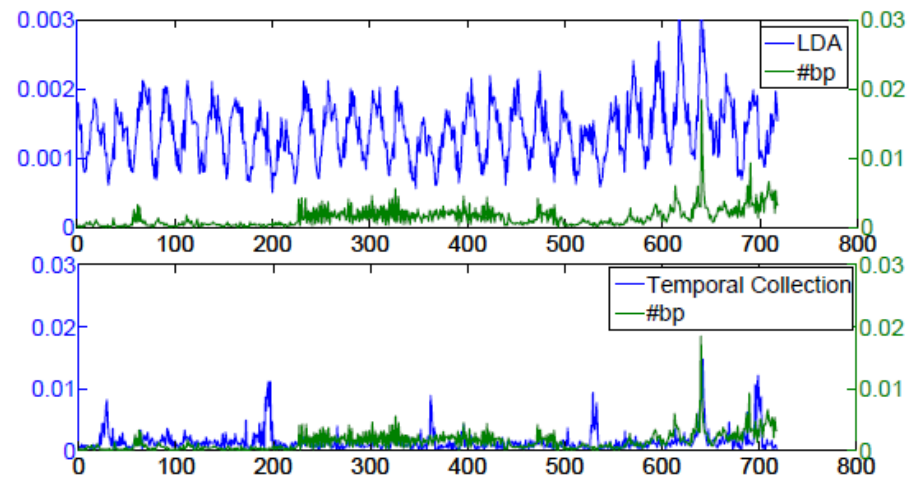
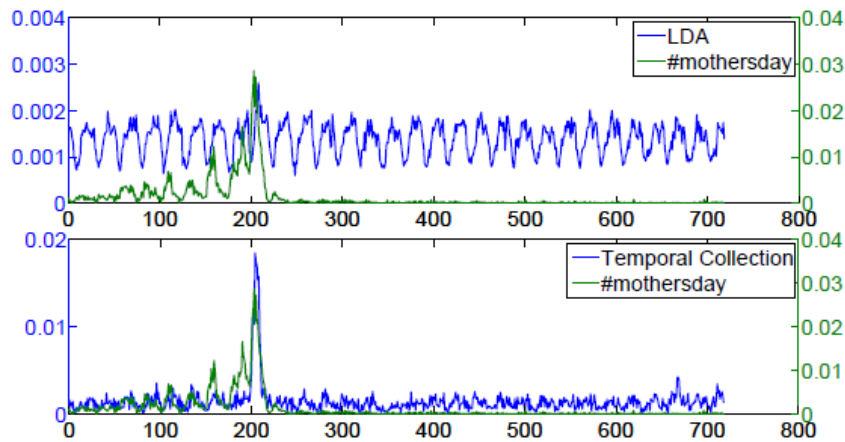

Temporal Dynamics & Geographical Language Variations

Conclusion

- A framework for modeling temporal dynamics for multiple sources.
- *Principled* way to tackle the problem.
- Bridge topic modeling & Information cascading.

Temporal Dynamics & Geographical Language Variations

Temporal Dynamics + Multiple Sources
Geographical Language Variations

Modeling Geographical Language Variations

Social Stream + Locations

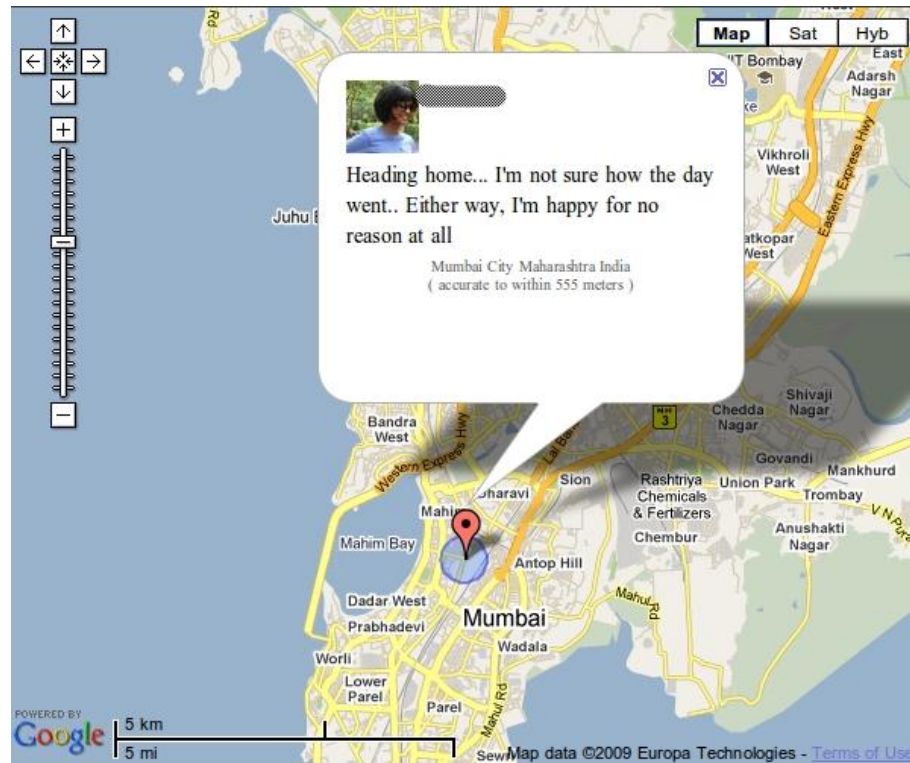

Modeling Geographical Language Variations

Interesting Questions

- How is information created and shared in different geographic locations? What is the inherent geographic variability of content?
- What are the spatial and linguistic characteristics of people? How does this vary across regions?
- Can we discover patterns in users' usage of micro-blogging services?

Modeling Geographical Language Variations

Interesting Questions

- How is information created and shared in different geographic locations? What is the inherent geographic variability of content?
- What are the spatial and linguistic characteristics of people? How does this vary across regions?
- Can we discover patterns in users' usage of micro-blogging services?
- **Can we predict user location from tweets?**

Modeling Geographical Language Variations

Applications

Behavioral targeting and user modeling



Better local information filtering

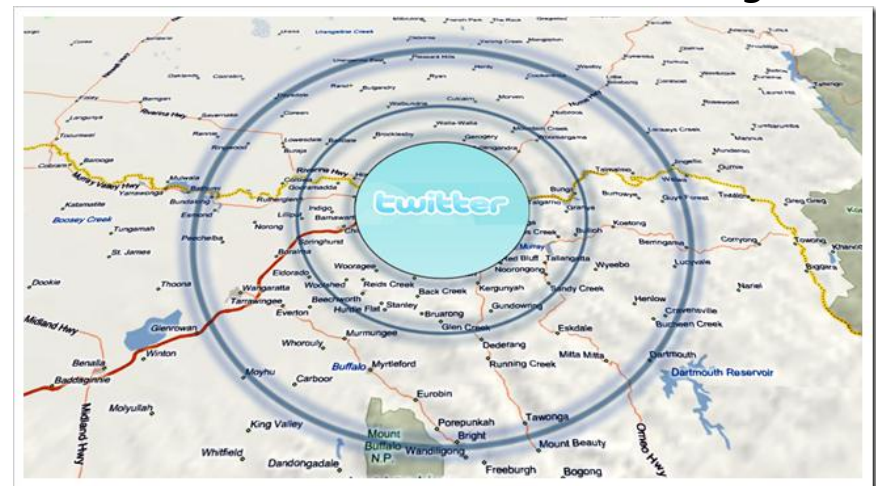

Modeling Geographical Language Variations

Technical Challenges

- Tweets
 - noisy and short (140 characters)
- Only 1% of tweets geo-tagged
 - Can we predict locations for non-tagged tweets?
- Many intuitions to be combined
 - Background, regional language models, topics
 - Personal preferences, regional preferences...

...

Modeling Geographical Language Variations

Can we really infer locations for a tweet?

Yes via tweet decomposition

Modeling Geographical Language Variations

Just landed after a long flight. It is raining here at Lyon though!

What is the user's location?

Modeling Geographical Language Variations

Just landed after a long flight. It is raining here at Lyon though!

background

just
after
It
be
the
can
cant
will

Modeling Geographical Language Variations

Just landed after a long flight. It is raining here at Lyon though!

Travel

landed
flight
delay
TSE
Gate
terminal

background

just
after
It
be
the
can
cant
will

Modeling Geographical Language Variations

Just landed after a long flight. It is raining here at Lyon though!

Travel/airport

landed
flight
delay
TSE
Gate
terminal

background

just
after
It
be
the
can
cant
will

SE airport area

Lyon
Saint
Exupery
convention
center
raining

Modeling Geographical Language Variations

Semantic
Topic

Travel/airport

landed
flight
delay
TSE
Gate
terminal

Background
Language
Model

background

just
after
It
be
the
can
cant
will

Regional
Language
Model

SE airport area

Lyon
Saint
Exupery
convention
center
raining

Modeling Geographical Language Variations

Delayed again at the TSE check point and
might miss my flight. way to go SF!

Travel/airport

landed
flight
delay
TSE
Gate
terminal

background

just
after
It
be
the
can
cant
will

SFO

SF
SFO
San
Francisco
airport

Modeling Geographical Language Variations

Can we always do that?

Modeling Geographical Language Variations

Life is good! Feeling great today!

Modeling Geographical Language Variations

Life is good! Feeling great today!

Daily life

life
feeling
good
today
morning

background

just
after
It
be
the
can
cant
will

?

Modeling Geographical Language Variations

Life is good! Feeling great today!

If we know something extra about the context and **user location preferences**, perhaps we can do better than random guessing!

Modeling Geographical Language Variations

Previous work

- Simple regional language models
 - No factorization
- No personal preferences
- Complicated inference algorithms
 - Usually two step process
 - Fails to learn coherent regions

Modeling Geographical Language Variations

- Motivations
- **Our Proposed Model**
- Experiments
- Conclusions

Modeling Geographical Language Variations

- A novel probabilistic model considers
 - Regional language models
 - Global topics
 - Personal preferences
- Sparse modeling + Bayesian treatment
- An efficient inference algorithm

Modeling Geographical Language Variations

- Basic Intuition
 - Regions
 - Topics
 - Users
 - Tweets
- The generative process
 - Intuition
 - Glory details

Modeling Geographical Language Variations

Basic Intuition: Region

- Must be coherent
 - There is **enough traffic** in it
 - Affects the way we write tweets
 - Has preference over **what topic discussed**
 - **Specific keywords**
 - Area over the map
 - Example
 - An airport
 - A park
 - A mall
 - A city

Modeling Geographical Language Variations

Basic Intuition: Topic

- Classify the content of the tweet
- Might not tell us the location
- Puts a distribution over words
- Examples
 - Sports
 - Politics
 - Travel
 - Daily life, etc

Modeling Geographical Language Variations

Basic Intuition: User

- Has preferences over locations
 - Where he usually spends his/her time
- Has preference over topics
 - What he tweets about

Modeling Geographical Language Variations

Basic Intuition: Tweet

- Written by a **given user**
- At a specific **location** (region)
 - Depends on the user
- About a **specific topic**
 - Depends on
 - What the user talks about
 - What is being discussed at this location
- Composed of a **bag of words** from
 - Topic + location + background language models

Modeling Geographical Language Variations

The Model

- Basic Intuition
 - Regions
 - Topics
 - Users
 - Tweets
- The generative process
 - Intuitive explanation
 - Glory details

Modeling Geographical Language Variations

How a tweet is being generated?

- Pick a location
- Pick a topic
- Generate the words

Modeling Geographical Language Variations

How a tweet is being generated?

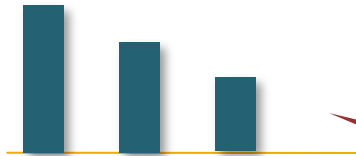

Preferences over regions
Regions are unsupervised
Just an area over the map

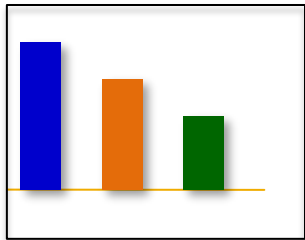

Preference over topics:
What he likes to talk about

Modeling Geographical Language Variations

How a tweet is being generated?

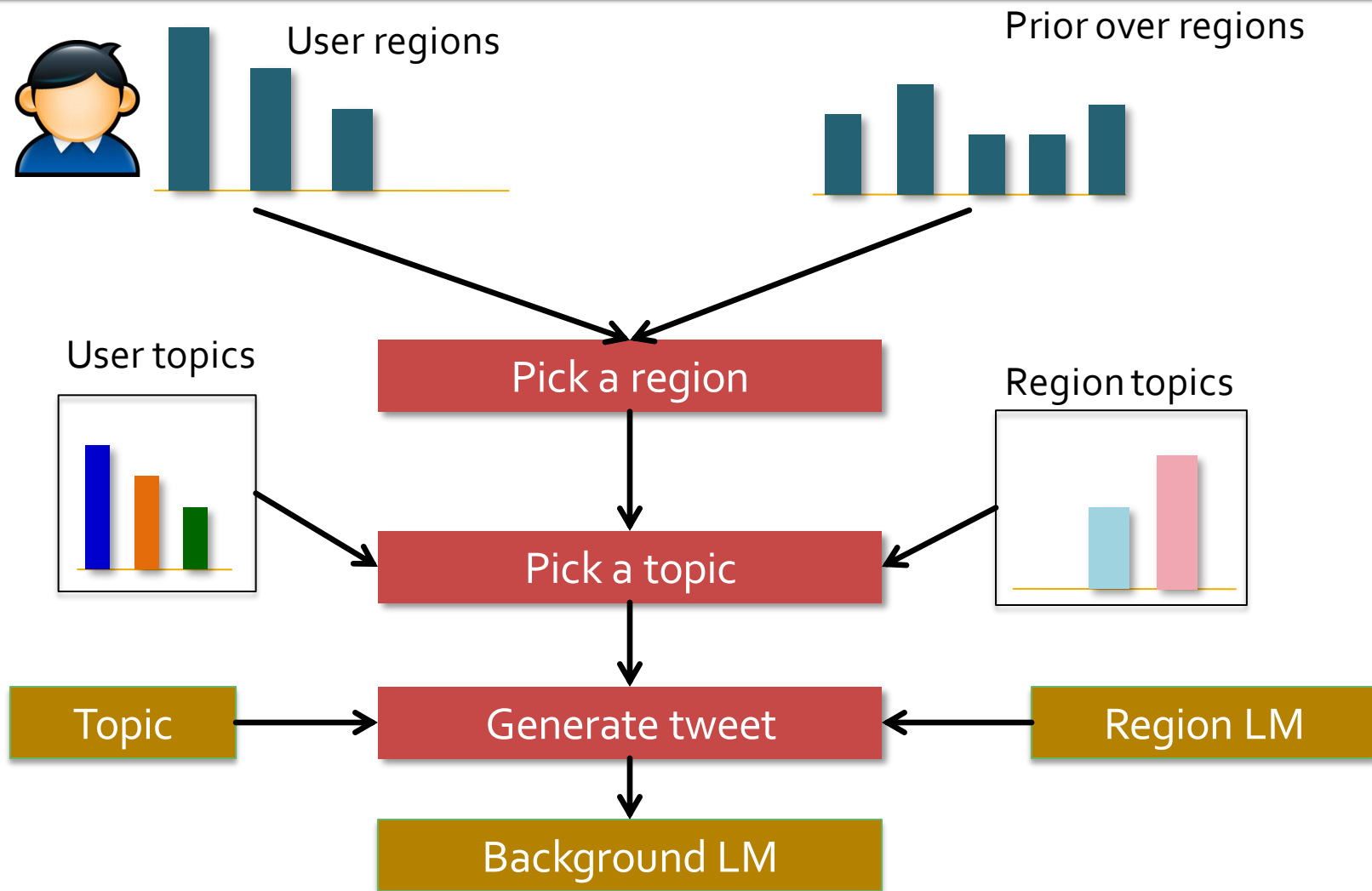

Modeling Geographical Language Variations

How a tweet is being generated?

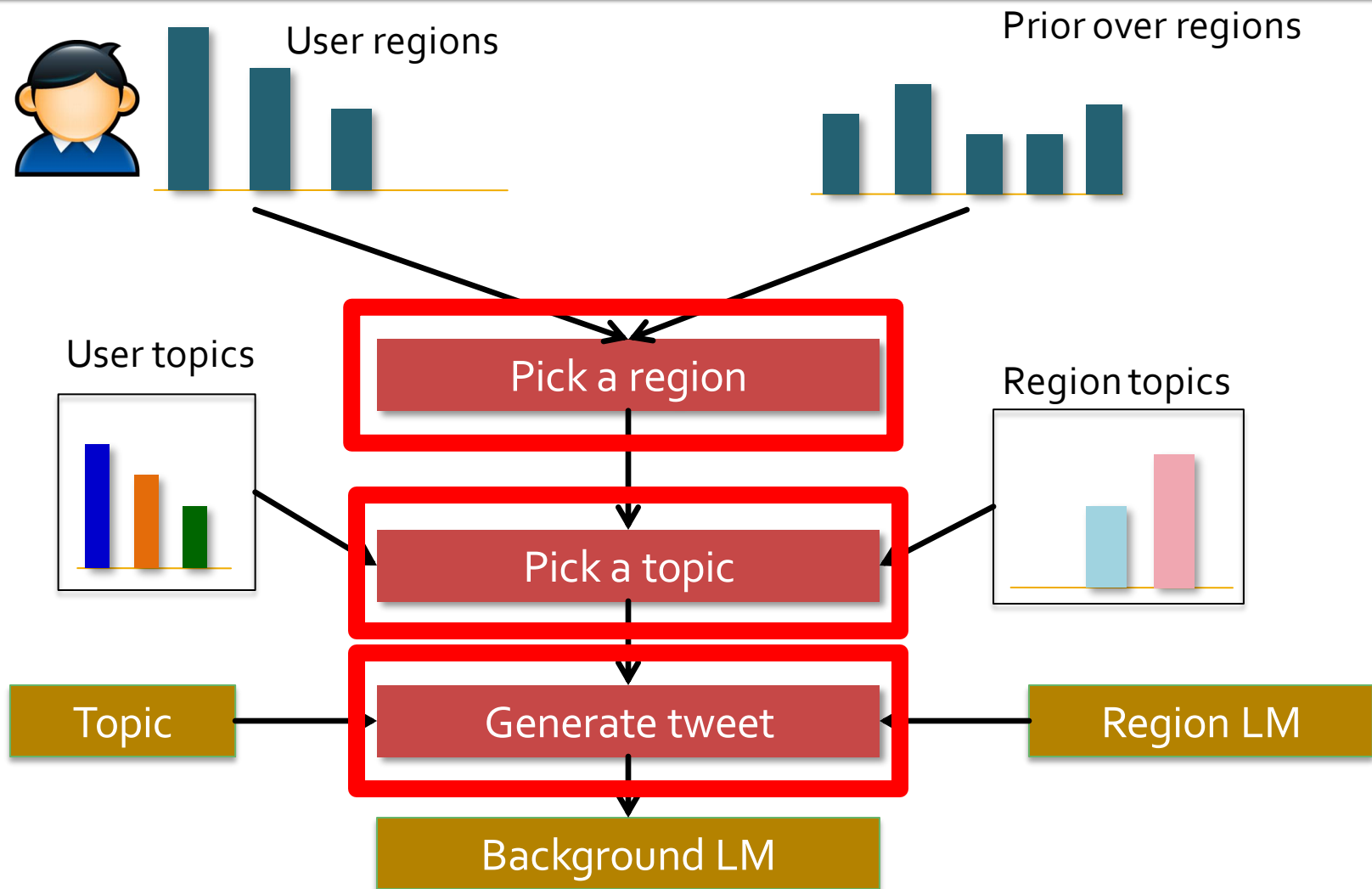

Modeling Geographical Language Variations

Discrete Additive Models

- Switch-based models
 - Normalized distributions
 - Pick one distribution
 - Sample from it
- SAGE [Eisenstein et. al, 2011]
 - Un-normalized distribution
 - Log frequencies
 - Add them all together
 - Exponentiate and sample

An Additive model for discrete distributions

- Discrete distribution via natural parameters

Example:

$$p(v|\phi) = \exp(\phi_v - g(\phi)) \quad \text{where } g(\phi) = \log \sum_v \exp(\phi_v)$$

- Log-frequency differences
- Addition of multiple models

Example:

$$P(v|\phi_0, \phi_u, \phi_g) := p(v|\phi_0 + \phi_u + \phi_g)$$

Modeling Geographical Language Variations

SAGE

Use SAGE to replace “switch” variables to enable us incorporate multiple sources in different levels of our model easily

- Language models
Example: background, regional, global...
- User preferences
Example: global, regional, personal...

...

Modeling Geographical Language Variations

SAGE

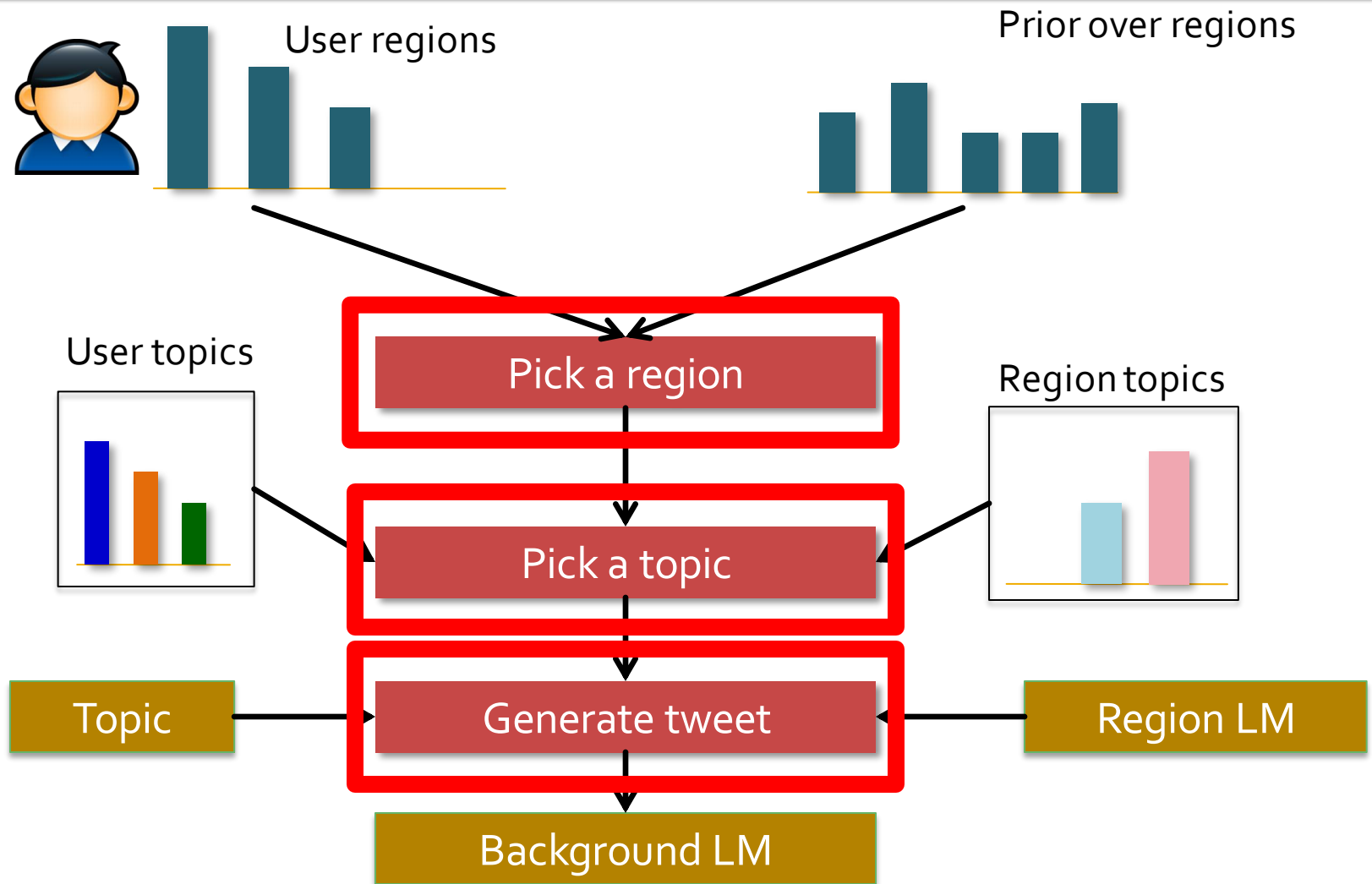

Modeling Geographical Language Variations

Recap

- Generative Process

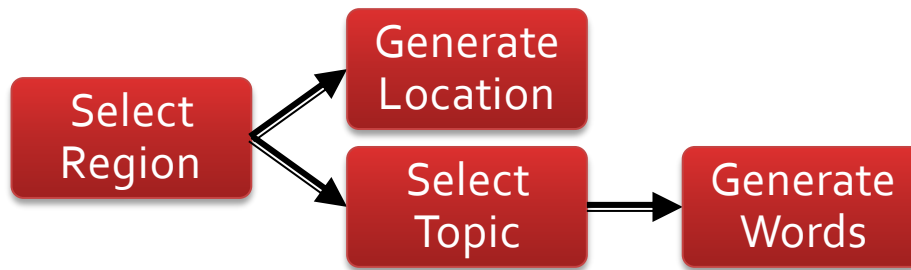

- Sparse Modeling

- L_1 regularization (Laplace priors)

- Geographical Modeling

- Bayesian treatment

Modeling Geographical Language Variations

Inference Algorithm

- A variant of Monte Carlo EM
 - “E-Step”: Sample latent discrete variables
 - “M-step”: Update all model parameters
-
- Sparse update of gradients
 - L_1 regularization: ISTA algorithm
 - Initialize regions with K-means algorithm

Modeling Geographical Language Variations

Experiments

Dataset

- Twitter data
 - Randomly sample 1,000 users
 - All tweets from Jan 2011 to May 2011
 - 573,203 distinct tweets
- Twitter geographical data
 - Locations + Twitter Places

Modeling Geographical Language Variations

Experiments

Location Prediction

- Metric
 - average error distance
 - Kilometers

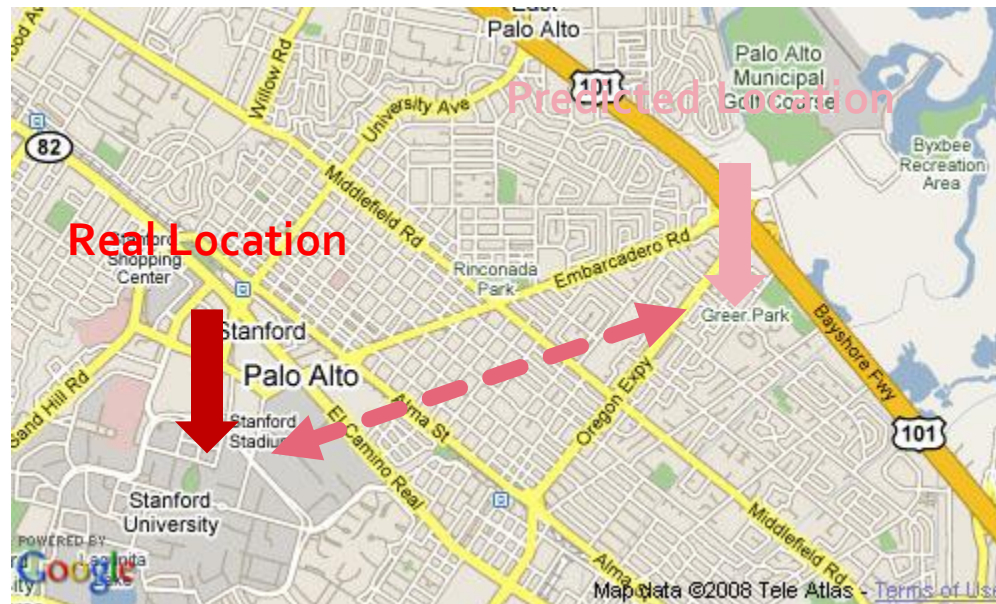

Modeling Geographical Language Variations

Experiments

Location Prediction

■ Baselines

- [Yin et al. WWW 2011] paper
 - PLSA formalism
 - No personalization
- Our model without ϕ^{geo} , η^{user} and θ^{user}
 - Similar to Yin et al.'s formalism but SAGE model
- Our model without η^{user} and θ^{user}

Modeling Geographical Language Variations

Location Prediction

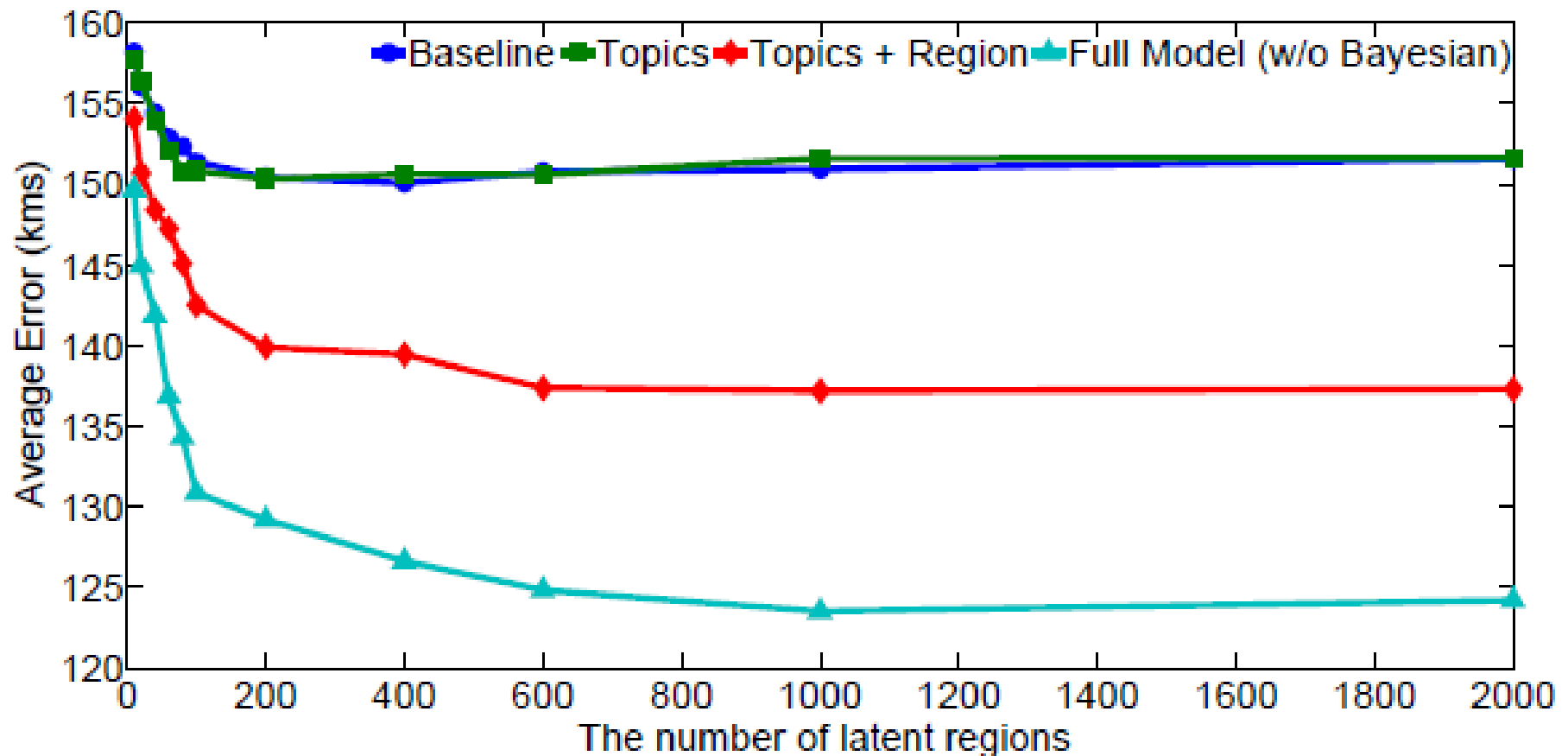

Modeling Geographical Language Variations

Bayesian Treatment

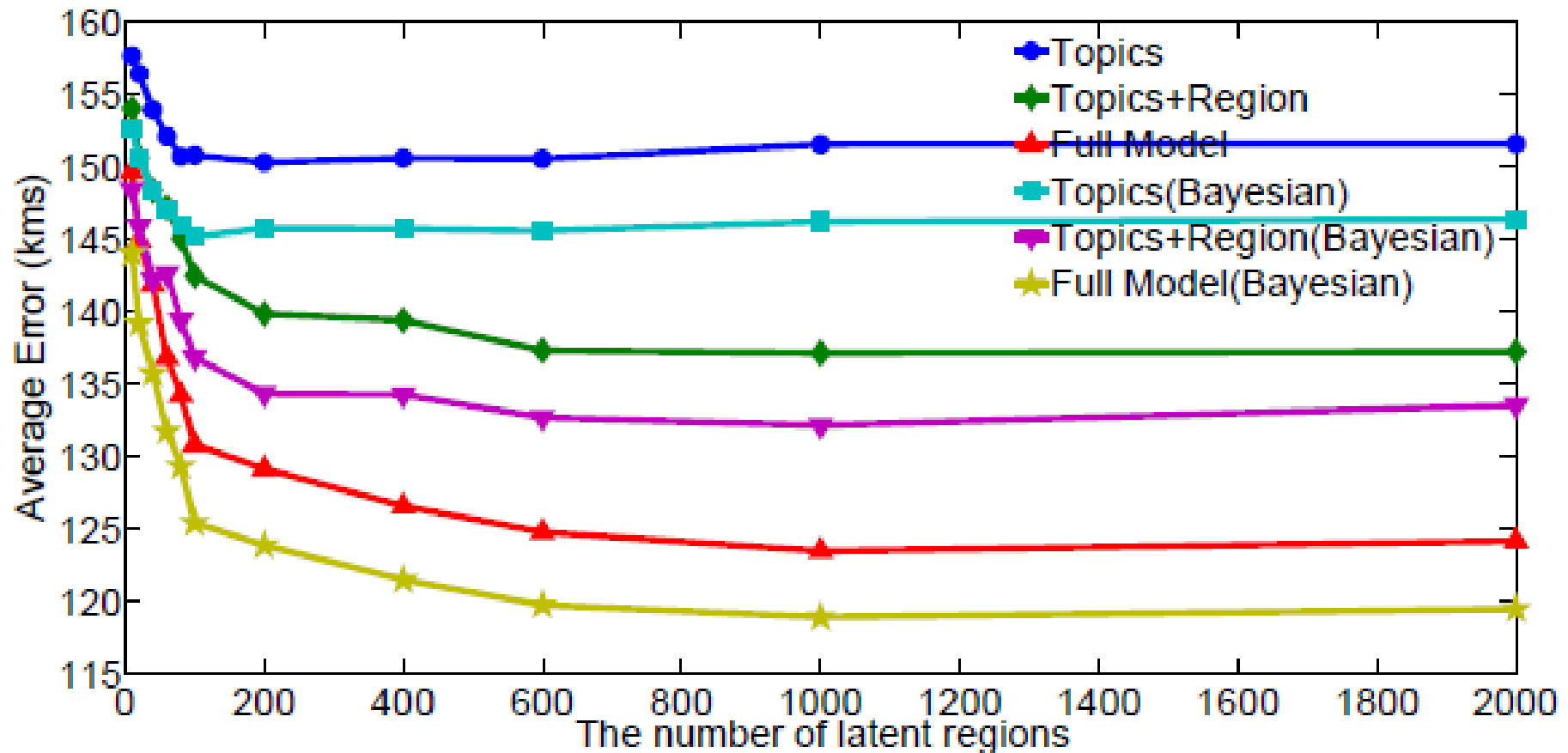

Modeling Geographical Language Variations

Number of Topics

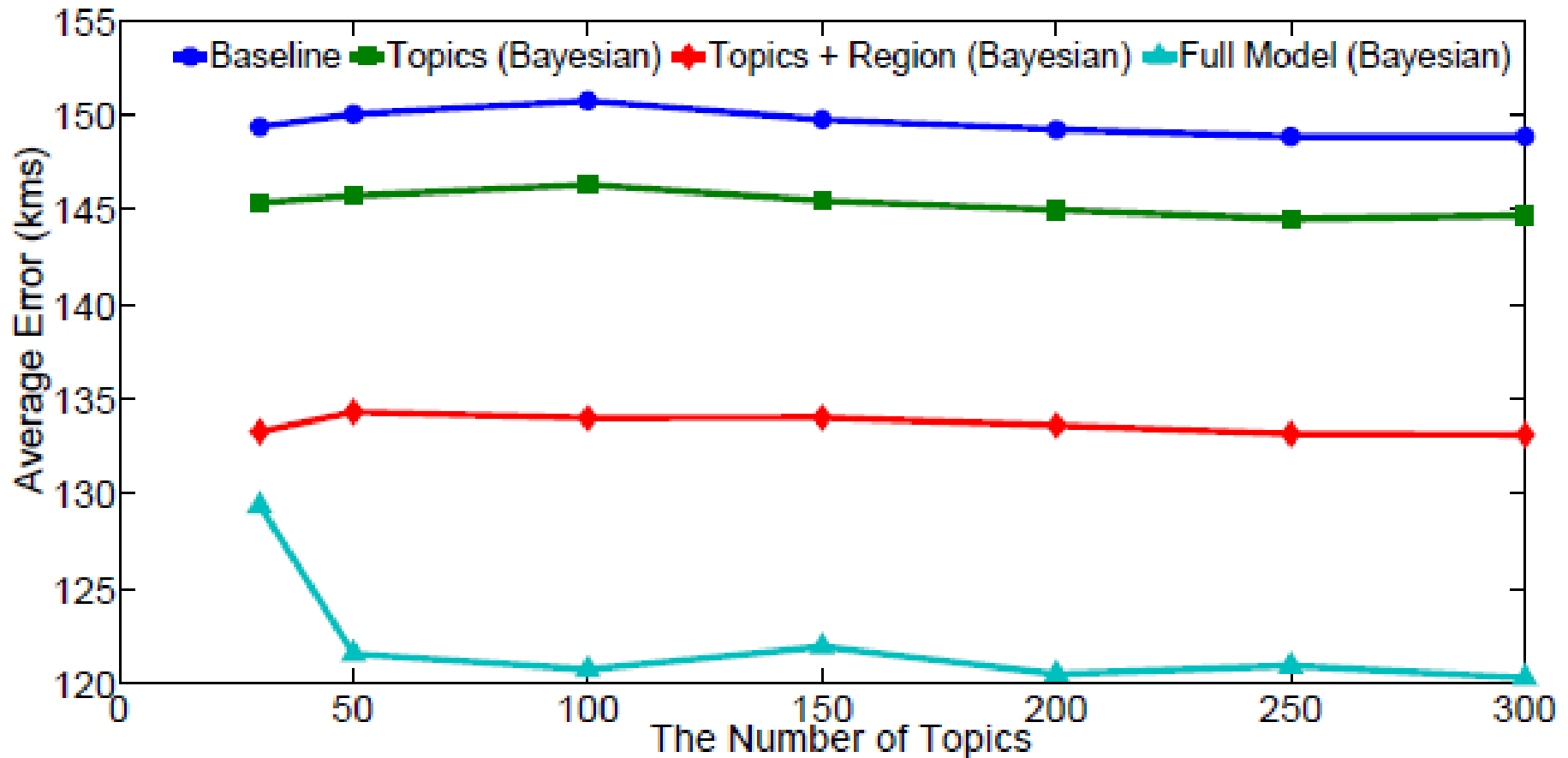

Modeling Geographical Language Variations

Number of Regions

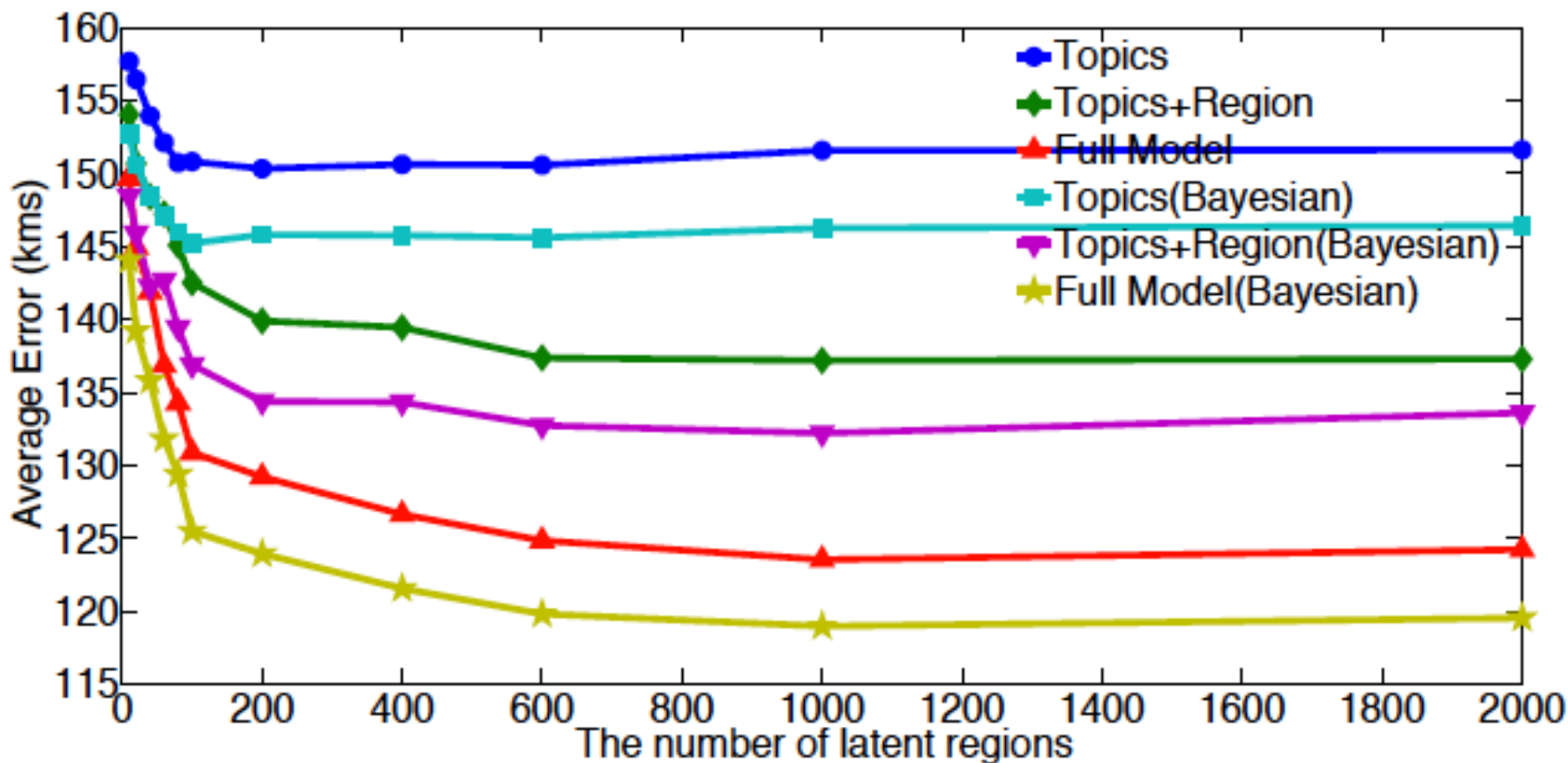

Modeling Geographical Language Variations Experiments (Public Data)

# of regions	[3]	[2]	[1]	Topics	Topics + Region	Full Model
10	494	479	501	540.60	481.58	449.45
20	494	479	501	522.18	446.03	420.83
40	494	479	501	513.06	414.95	395.13
60	494	479	501	507.37	410.09	380.04
80	494	479	501	499.42	408.38	374.01
100	494	479	501	498.94	407.78	372.99

[1] Eisenstein et al. EMNLP 2010.

[2] Wing and J. Baldridge. ACL 2011.

[3] Eisenstein, Ahmed, Xing ICML 2011.

Modeling Geographical Language Variations

Error Analysis

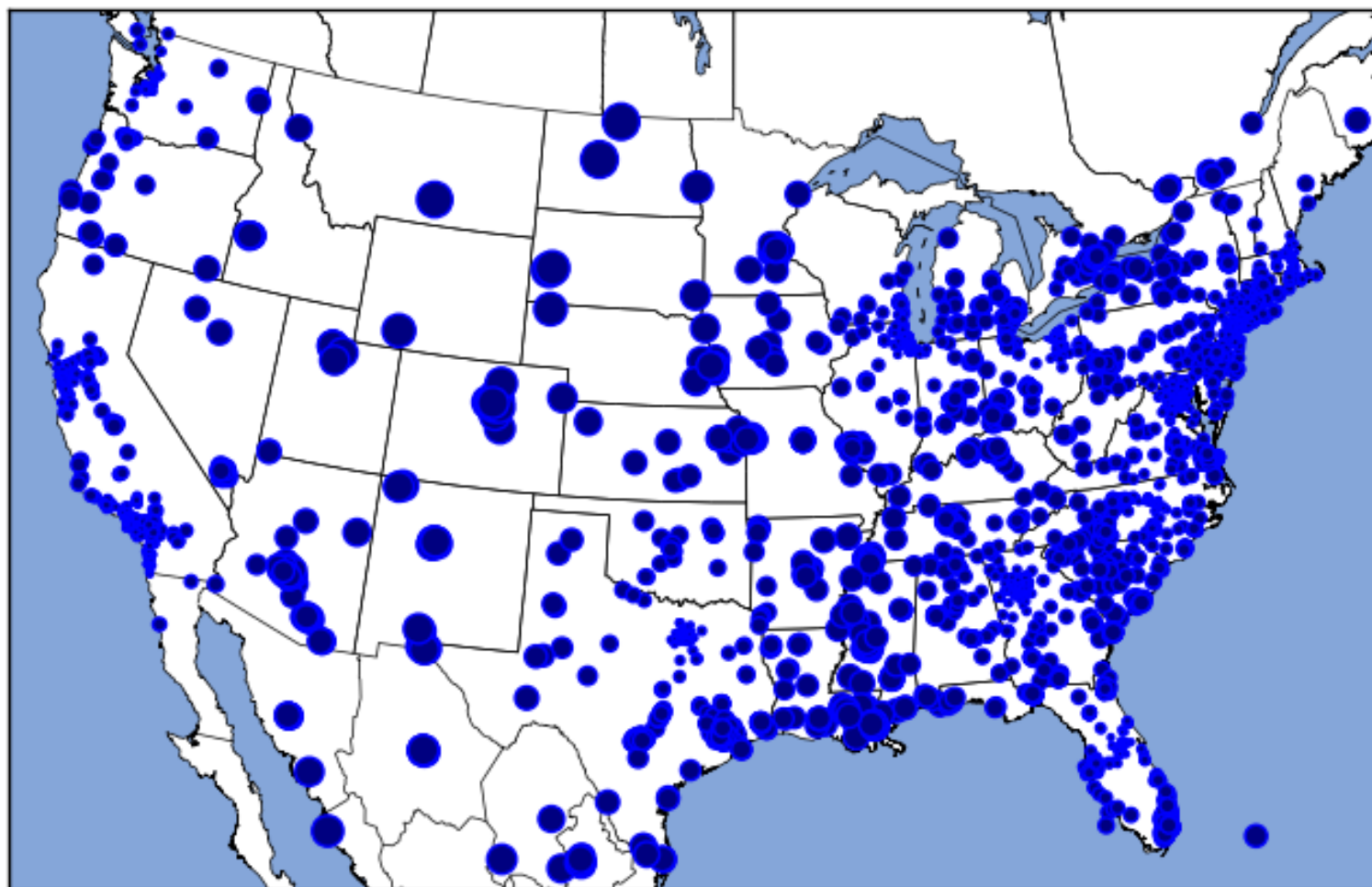

Modeling Geographical Language Variations

Global and local topics

Entertainments

lady beiber album music beats artist video listen
itunes apple produced movies #bieber lol new songs

Sports

yankees match nba football giants wow win winner game
weekend horse #nba

Politics

obama election middle east china uprising egypt russian
tunisia #egypt afghanistan people eu

Location with Top Ranked Terms

United States->New York->Brooklyn

brooklyn ave flatbush avenue mta prospect 5th #brooklyn spotlight carroll bushwick museum broadway madison
vanderbilt coney slope eastern subway new york pkwy #viernesnayobon #mets otsego greenwich starbucks

United States->California->San Francisco

sfo francisco san airport international millbrae terminal flight burlingame bart mateo boarding bayshore telecommute
landed heading bay airlines united bound flying #sfo caminogroupon caltrain moon tsa baggage california engineer valley

United States->Pennsylvania->Philadelphia

philadelphia #philadelphia phl #jobs market others #job street philly walnut septa chestnut the cherry
sansom arch spruce citizens locust btw temple pennsylvania rittenhouse passyunk bitlyetq7a6 bookrenters pike international

United Kingdom->England->London

winds lhr hounslow terminal the cloudy mph ickenham bath heathrow temperature airport car only airways uxbridge sun
splendid fair london british lounge tothers harmondsworth speedbird whens for stars day flight dominos navigation brunel

Australia->New South Wales->Sydney

sydney #sydney bondi george street mascot domestic syd surry station cnr platforms harbour darlinghurst qantas hoteloxford
eddy haymarket terminal wales australia chalmers uts pitt #marketing junction darling centre #citijobs citigroup druit

Modeling Geographical Language Variations

Conclusions

- Probabilistic model for geographical information
 - Regional variations
 - Personal preferences
- Effective inference algorithm
- Best location prediction
- Discriminatively learned language models
- Future work
 - Hierarchical model
 - Hash tags
 - Temporal location model

A little bit more about me ...



- Ph.D. candidate at Lehigh (5.5 years)
- Published 10+ technical papers
 - KDD (3), SIGIR (2[1]), WWW (1[2]), WSDM (1) , AAI (1) and CIKM ([1])
 - Best Poster in WWW 2011
- Four internships
 - Yahoo! Labs (2010, 2011)
 - LinkedIn (2011)
 - A local software company (2008)
- Collaborated with Alex Smola (Google) , Amr Ahmed (Google), Marco Pennacchiotti (eBay), Siva Gurumurthy (Twitter), Kostas Tsioutsoulis (Twitter), Jian Guo (Harvard Univ.), Ron Bekkerman (LinkedIn), Brian D. Davison (Lehigh Univ.), Dawei Yin (Lehigh Univ.), Ovidiu Dan (Microsoft), Zaihan Yang (Lehigh Univ.), Zhenzhen Xue (Google)

Questions?

Modeling Temporal Dynamics

Handling Multiple Sources

Generative Process

1. For all common topics T_c , draw $\phi^{(c)} \sim \text{Dir}(\beta^{(c)})$
2. For a particular stream s
 - (a) For all local topics T_s , draw $\phi^{(s)} \sim \text{Dir}(\beta^{(s)})$
 - (b) For each document d in s
 - i. Draw Bernoulli parameter $\eta_{s,d} \sim \text{Beta}(\gamma_s^{(s)}, \gamma_s^{(c)})$
 - ii. Draw $\theta_d^{(s)} \sim \text{Dir}(\alpha_s)$
 - iii. Draw $\theta_d^{(c)} \sim \text{Dir}(\alpha_c)$For each word position i in document d
 - A. Draw $x_{di} \sim \text{Bernoulli}(\eta_{s,d})$
 - B. Draw a topic $z_{di} \sim \text{Multinomial}(\theta_d^{(x_{di})})$
 - C. Draw a word $w_{di} \sim \text{Multinomial}(\phi_{z_{di}}^{(x_{di})})$

Modeling Temporal Dynamics

Handling Multiple Sources

Approximate Inference

- Gibbs Sampling

$$p(x_{di} = s, z_{di} = t) \propto$$

$$\frac{c_{d,s-i} + \gamma_s}{N_d + \gamma_s + \gamma_c - 1} \frac{m_{d,z-i} + \alpha_z}{\sum_{z \in T_s} m_{d,z-i} + \alpha_z} \frac{n_{z,w-i} + \beta_w^{(s)}}{\sum_w^V n_{z,w-i} + \beta_w^{(s)}}$$

$$p(x_{di} = c, z_{di} = t) \propto$$

$$\frac{c_{d,c-i} + \gamma_c}{N_d + \gamma_s + \gamma_c - 1} \frac{m_{d,z-i} + \alpha_z}{\sum_{z \in T_c} m_{d,z-i} + \alpha_z} \frac{n_{z,w-i} + \beta_w^{(c)}}{\sum_w^V n_{z,w-i} + \beta_w^{(c)}}$$

Temporal Modeling

- Temporal Function

$$V(t + 1) = cf[V(t)]\delta(t)$$

- $V(t)$: volume of the story
- $f(v)$: a function of volume, encode “popularity”
- $\sigma(t)$: a function of time, encode “decay”

Temporal Modeling

- Temporal Function

For some choices of function f and σ , we can analytically solve volume $V(t)$:

$$A_k t^{M_k} \exp(-L_k t)$$

Modeling Temporal Dynamics

Temporal Modeling

- Overall Algorithm

initialize Gibbs Sampler

while not converge **do**

E-step

For all documents in all text streams, update topic assignments using Equation (1)

M-step

Update α , β and γ values through the method introduced in [16]

for each all local and common topics **do**

1) Fit “Gaussian” function to α values

2) Fit “Temporal Gamma” function by using the parameters from the previous step

3) Re-calculate α values for topic k by using fitted function

end for

end while

Modeling Geographical Language Variations

Generative Process: Details

Notations

Symbol	Size	Usage
η^0	$1 \times \mathbb{R}$	global region distribution
η^{user}	$\mathbb{U} \times \mathbb{R}$	user-dependent region distribution
θ^0	$1 \times \mathbb{K}$	global topic distribution
θ^{geo}	$\mathbb{R} \times \mathbb{K}$	region-dependent topic distribution
θ^{user}	$\mathbb{U} \times \mathbb{K}$	user-dependent topic distribution
ϕ^0	$1 \times \mathbb{V}$	global term distribution
ϕ^{geo}	$\mathbb{R} \times \mathbb{V}$	region-dependent term distribution
Π	$\mathbb{K} \times \mathbb{V}$	a global topic matrix
μ	\mathbb{R}^2	mean location of a latent region
Σ	$\mathbb{R}^{2 \times 2}$	covariance matrix of a latent region

Modeling Geographical Language Variations

The Graphical Model

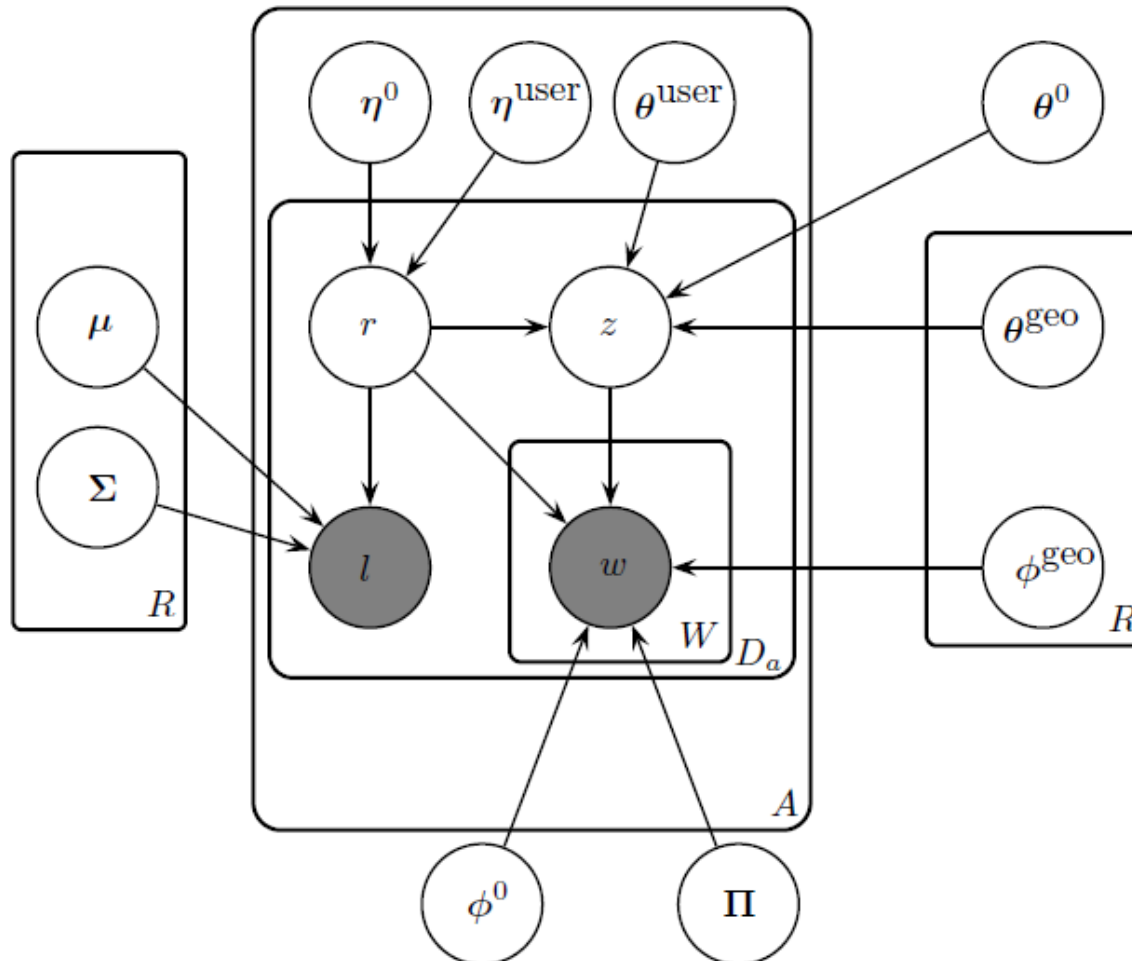

Modeling Geographical Language Variations

The Graphical Model

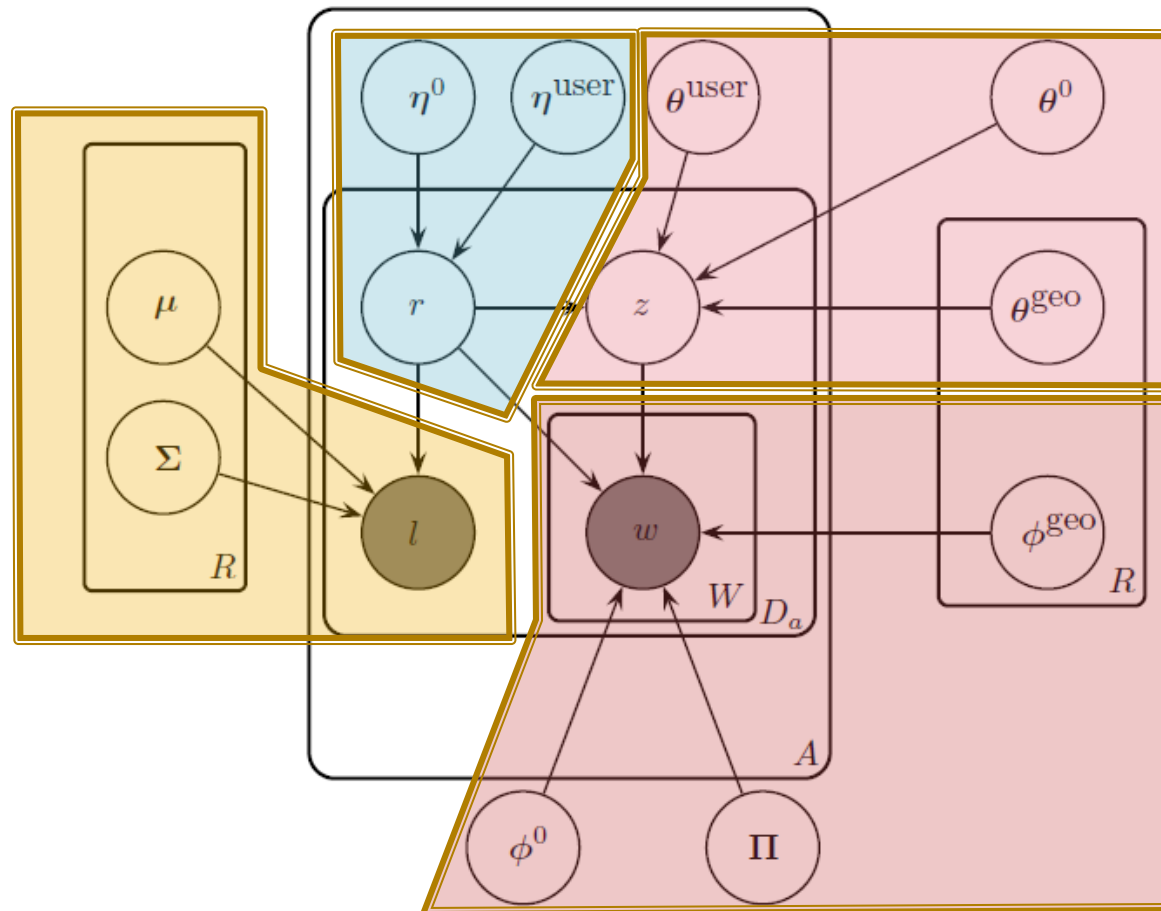

Modeling Geographical Language Variations

Region Selection

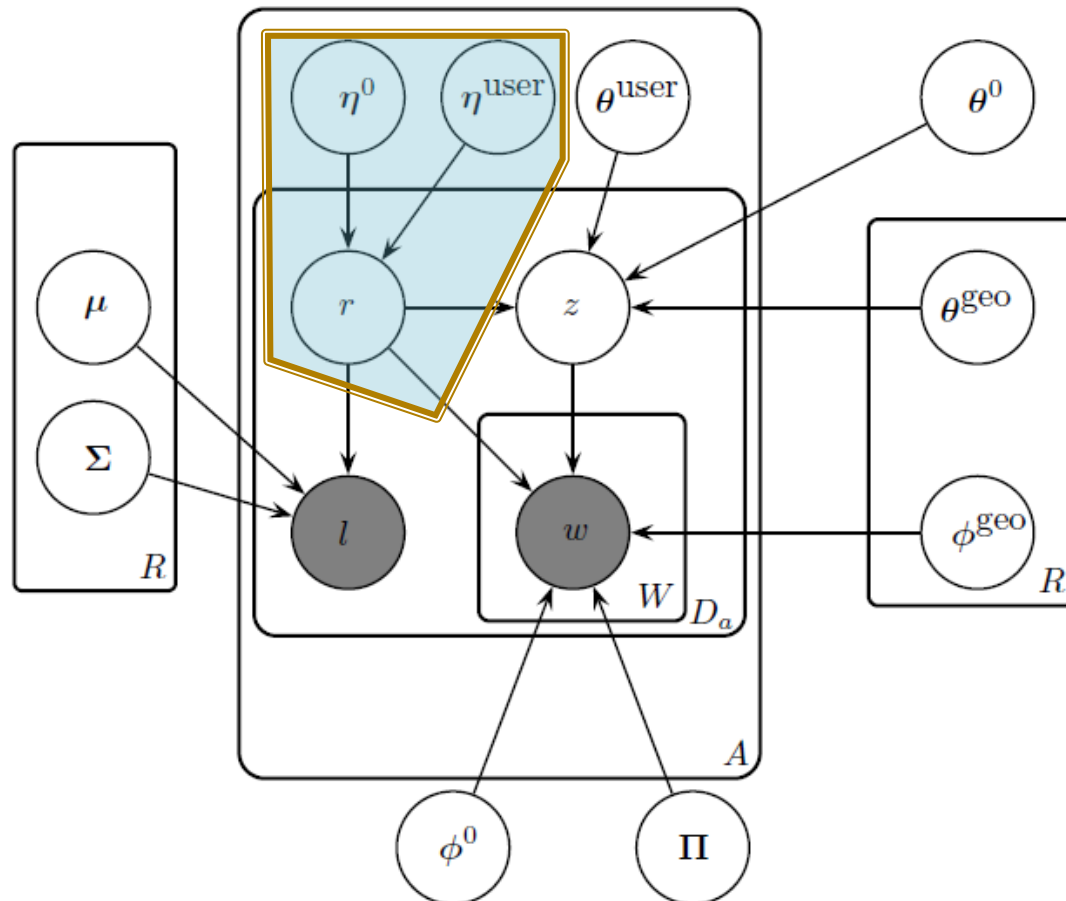

Modeling Geographical Language Variations

Region Selection

Step-by-Step

- Users tend to appear in a handful geographical locations.

$$P(r|\eta^0, \eta_u^{\text{user}}) = p(r|\eta^0 + \eta_u^{\text{user}})$$

Modeling Geographical Language Variations

Location Generation

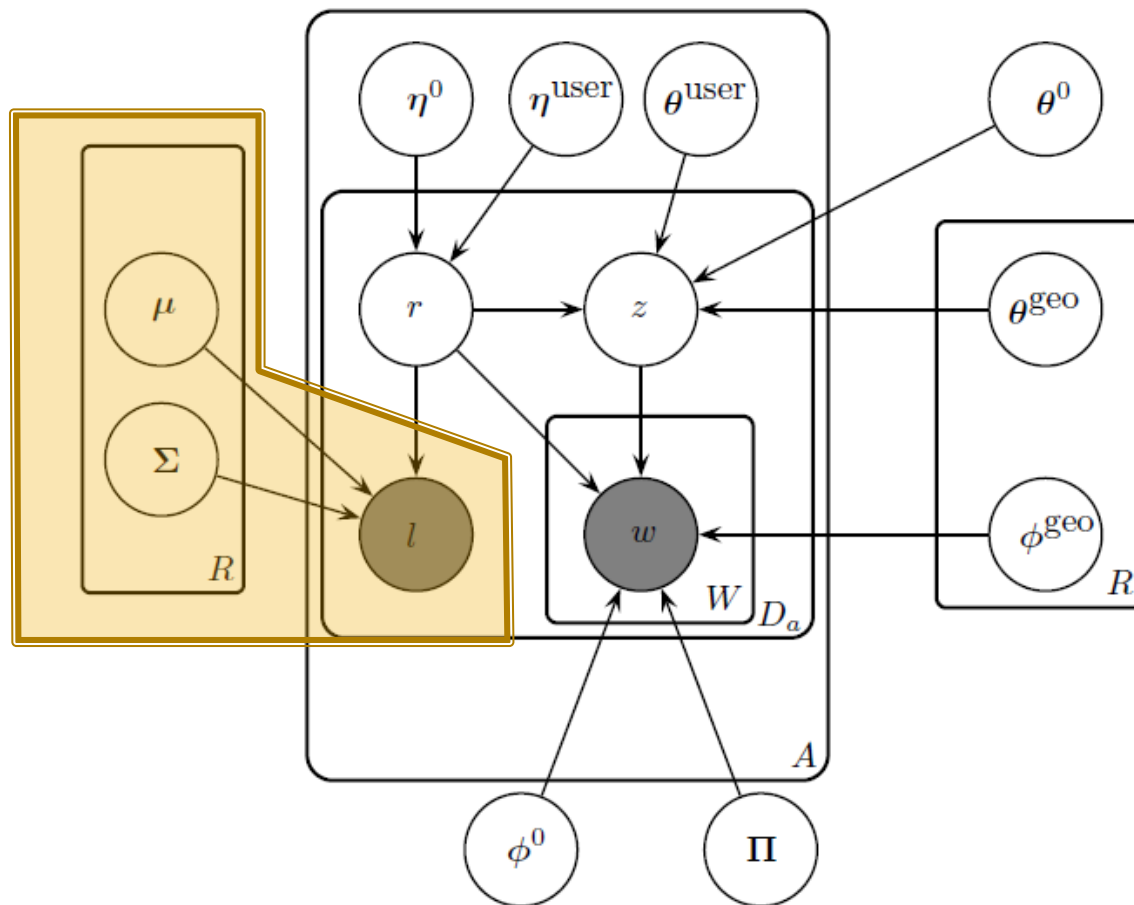

Modeling Geographical Language Variations

Location Generation

- Once a region is selected, locations can be generated.

$$\mathbf{l}_d \sim \mathcal{N}(\boldsymbol{\mu}_r, \boldsymbol{\Sigma}_r).$$

Modeling Geographical Language Variations

Topic Selection

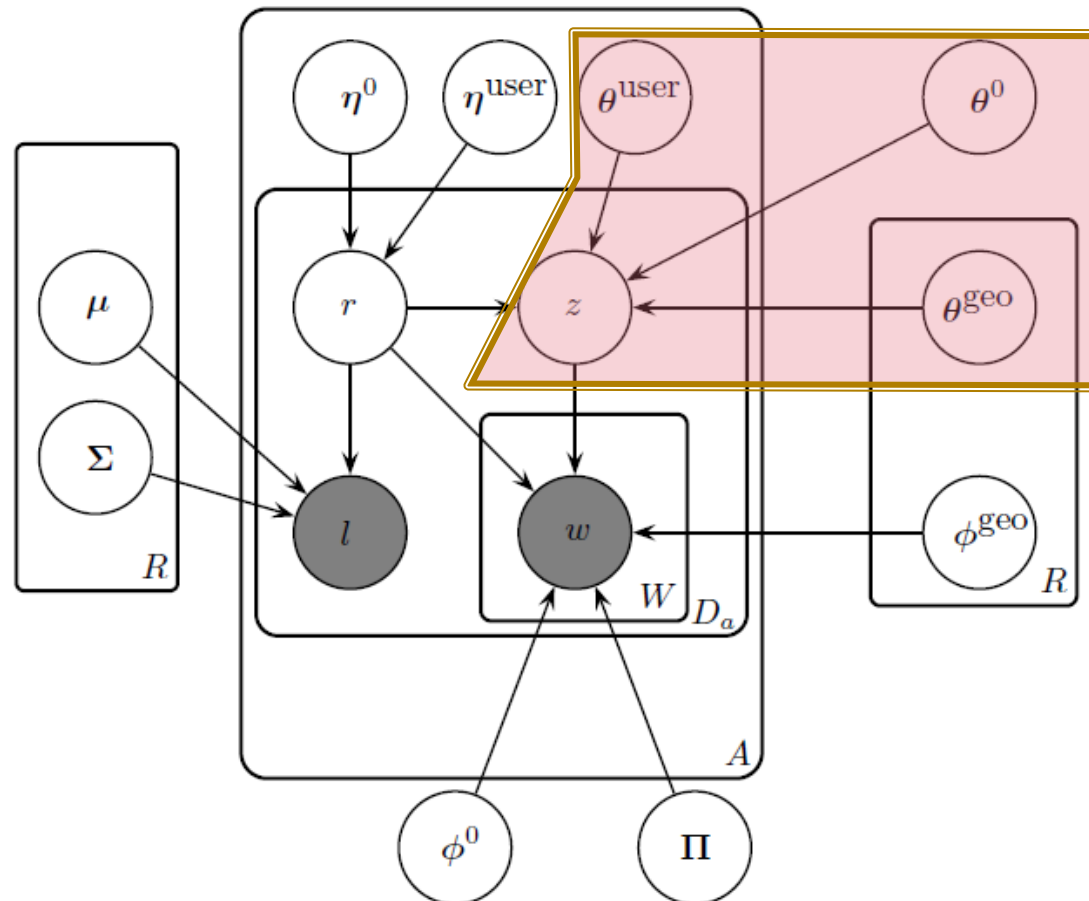

Modeling Geographical Language Variations

Topic Selection

- Topics have different chances to be discussed in different regions by different users

$$P(z|\theta^0, \theta_u^{\text{user}}, \theta_r^{\text{geo}}) = p\left(z|\theta_j^0 + \theta_{u,j}^{\text{user}} + \theta_{r,j}^{\text{geo}}\right)$$

Modeling Geographical Language Variations

Word Generation

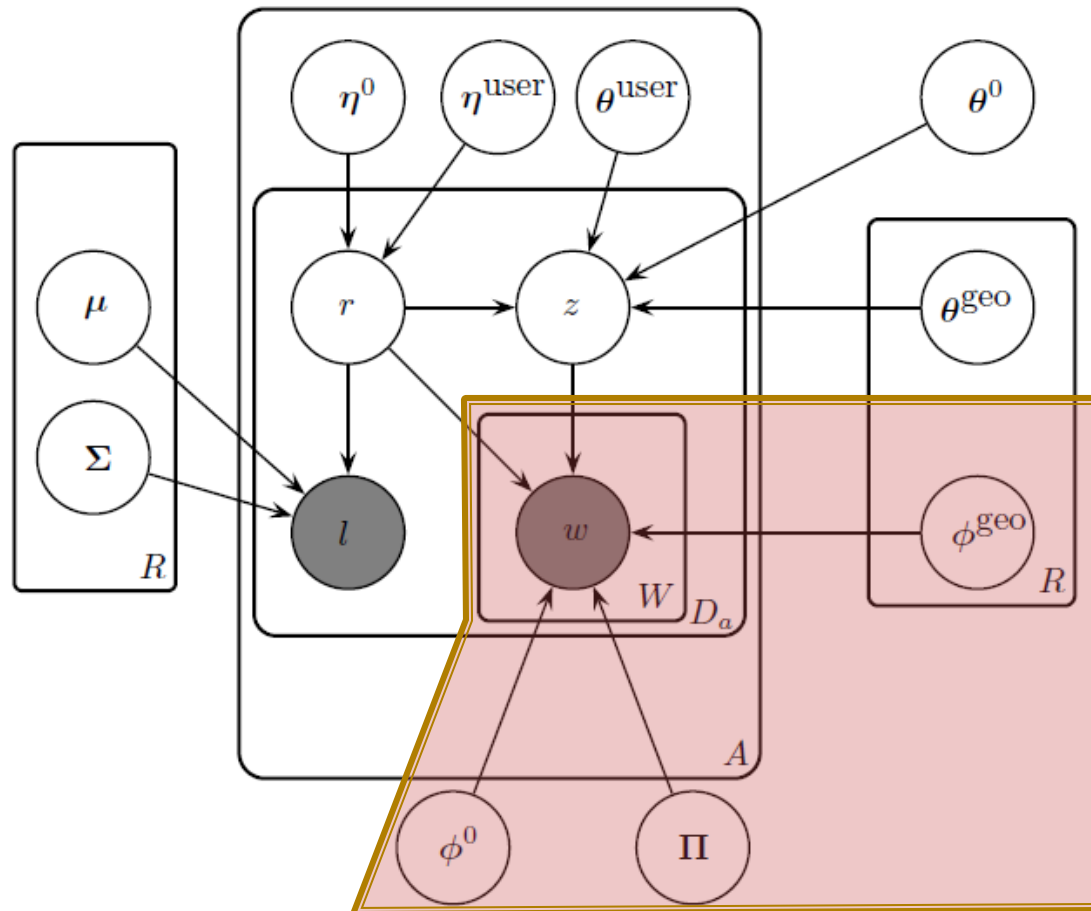

Modeling Geographical Language Variations

Word Generation

- Words used in a tweet depend on both the location and topic of the tweet.

$$P(w|z, \phi^0, \phi_r^{\text{geo}}, \mathbf{\Pi}_z) = p(w|\phi^0 + \phi_r^{\text{geo}} + \mathbf{\Pi}_{z_d})$$

Modeling Geographical Language Variations

Sparse Modeling

- Laplace Priors

$$\eta_r^0 \sim \mathcal{L}(0, \omega^0) \quad \eta_{u,r}^{\text{user}} \sim \mathcal{L}(0, \omega_u)$$

$$\theta_z^{\text{geo}} \sim \mathcal{L}(0, \lambda_l) \quad \theta_{u,z}^{\text{user}} \sim \mathcal{L}(0, \lambda_u) \quad \theta_{r,z}^{\text{geo}} \sim \mathcal{L}(0, \lambda_r)$$

$$\phi_v^0 \sim \mathcal{L}(0, \psi^0) \quad \phi_{r,v}^{\text{geo}} \sim \mathcal{L}(0, \psi_l)$$

$$\mathbf{\Pi}_{z,v} \sim \mathcal{L}(0, \psi_t)$$

Sparsity results in
predictive models

Modeling Geographical Language Variations

Bayesian treatment

- Prior distributions over mean and covariance matrix
- Jeffery prior

$$\mu \sim \text{Unif.}$$

$$P(\Sigma) \propto |\Sigma|^{-(3/2)}.$$

- Penalize large regions
 - We want region to be predictive as much as the data supports